



RADIO REMOTE CONTROL

M550

User's Manual

No part of this manual may be reproduced in any way without written authorization from IMET. This manual is subject to change with no further notice. Every possible care has been taken in compiling and verifying the contents of this manual; however, IMET declines any responsibility deriving from using the manual or from any errors or omissions in the information contained herein. Furthermore, IMET cannot be held responsible for damages or problems deriving from using non-original accessories or spare parts. The same applies to any person or company involved in the realization of this manual.

*M550 ALL1-EN.doc 3rd edition- 04 July 2012
IMET S.r.l. via Fornace no. 8, 33077 Sacile (PN) Italy
Tel +39.0434.7878 Fax +39.0434. 737848*

CONTENTS

CONTENTS	2
INTRODUCTION	4
1. IDENTIFICATION DATA	5
1.1. DOCUMENTATION.....	6
2. CONVENTIONS USED IN THIS MANUAL	7
3. CAUTION	7
3.1. RISK ANALYSIS.....	7
3.2. APPLICATIONS.....	7
4. PREVENTIVE MAINTENANCE	8
4.1. ROUTINE MAINTENANCE TO BE CARRIED OUT BY OPERATOR.....	8
4.2. MAINTENANCE AND INTERNAL CHECKS.....	8
5. INSTALLING THE RADIO REMOTE CONTROL	9
5.1. RECEIVING UNIT DIMENSIONS AND DRILLING DIAGRAM	9
5.2. CONNECTING THE RECEIVER	11
5.2.1. INSTALLING THE EXTERNAL ANTENNA	11
5.2.2. STOP (E-STOP)	12
5.2.3. SAFETY STOP (S-STOP).....	12
5.3. BASIC FUNCTIONS.....	13
5.4. CONNECTION DIAGRAMS OF H RECEIVERS	13
5.4.1. H RECEIVER WITH ANALOG OUTPUT CARD AND DATA FEEDBACK CARD.....	14
5.4.2. POWER SUPPLY CONNECTIONS OF H-DC AND H-AC RECEIVERS	15
5.4.3. ANALOG COMMAND CARD.....	16
5.4.4. LOGIC BOARD.....	17
5.4.5. DATA FEEDBACK CARD	17
5.4.6. RELAY CONTROL CARDS	18
5.4.7. POTENTIOMETER CARD.....	18
5.5. CONNECTION DIAGRAMS FOR L AND K RECEIVERS	19
5.5.1. L-AC VERSION	19
5.5.2. L-DC VERSION	20
5.5.3. K VERSION	21
5.5.4. RELAY CONTROL CARDS FOR L AND K RECEIVERS.....	22
5.5.5. OTHER CONTROL CARDS FOR L-DC AND K-DC RECEIVERS.....	23
5.6. SERIAL DATA TRANSMISSION.....	24
5.6.1. USER SERIAL (RS232).....	24
5.6.2. SERIAL CONNECTION CABLE.....	24
5.7. CONNECTION DIAGRAMS FOR M-AC RECEIVERS	25
5.7.1. M-AC RECEIVER	25
5.7.2. COMMON CONNECTIONS ON M-AC TRANSCEIVERS	26
5.7.3. M-AC TRANSCEIVERS: DATA ACQUISITION CONNECTIONS.....	27
6. USING THE RADIO REMOTE CONTROL	28
6.1. SAFETY RULES	28
6.2. POWERING AND STARTING THE RADIO REMOTE CONTROL	28
6.3. STOP	28
6.4. TURNING OFF THE REMOTE CONTROL.....	28
6.5. AUTO POWER-OFF.....	28
6.6. MEANING OF LEDs.....	29
6.7. TRANSMITTING UNIT POWER SUPPLY.....	30
6.7.1. BATTERY STATE OF CHARGE	30
6.7.2. CHANGING AND CHARGING THE BATTERY	30
6.8. DIP-SWITCH PROGRAMMABLE OUTPUT CONFIGURATIONS.....	31
7. RADIO REMOTE CONTROL OPTIONS	32

7.1.	MTRS AND MTRS EASY OPTION	32
7.1.1.	TRANSMITTER	32
7.1.1.1.	DEFINITION OF COMBINATION	32
7.1.1.2.	SELECTING THE DESIRED COMBINATION	32
7.1.1.3.	LOCK PROCEDURE	32
7.1.1.4.	RADIO REMOTE CONTROL START-UP	33
7.1.1.5.	UNLOCK PROCEDURE	33
7.1.1.6.	FREQUENCY CHANGE	33
7.1.2.	RECEIVER	33
7.1.3.	ANOMALIES	34
7.2.	DSC OPTION	34
7.3.	IREADY OPTION	35
7.3.1.	WARNINGS	35
7.3.2.	TRANSMITTER	35
7.3.3.	RECEIVER	35
7.3.4.	OPERATION	36
7.3.5.	TECHNICAL CHARACTERISTICS	37
8.	CHANGING THE OPERATING FREQUENCY	38
8.1.	BEFORE CHANGING FREQUENCY	38
8.2.	CHANGING FREQUENCY	38
8.3.	AVAILABLE FREQUENCIES	39
9.	TROUBLESHOOTING	40
9.1.	MALFUNCTIONS IN THE TRANSMITTER'S STOP CIRCUIT	41
9.2.	PASSIVE EMERGENCY	41
9.3.	TECHNICAL ASSISTANCE	41
10.	TECHNICAL SPECIFICATIONS	42
10.1.	WAVE TRANSMITTER	43
10.2.	THOR AND ZEUS TRANSMITTERS	43
10.3.	S1, S2 AND G4 TRANSMITTERS	43
10.4.	M8 TRANSMITTER	43
10.5.	H RECEIVERS	44
10.6.	L RECEIVER	45
10.7.	K RECEIVER	46
10.8.	M-AC RECEIVERS	47
10.9.	CB5000-AC, CB5000-DC BATTERY CHARGERS FOR WAVE TRANSMITTERS	49
10.10.	CB3600-AC, CB3600-DC BATTERY CHARGER FOR THOR AND ZEUS TRANSMITTERS	49
10.11.	CB6000-AC, CB6000-DC BATTERY CHARGER FOR S1, S2 AND G4 TRANSMITTERS	50
11.	RADIO REMOTE CONTROL SPARE PARTS LIST	51
12.	DISPOSAL	52
	ANNEXES	52
	ANNEX A	
	ANNEX B	
	ANNEX C	
	ANNEX D FOR K-DC RECEIVERS	52
	OTHER ANNEXES.....	52
13.	DECLARATION OF CONFORMITY 0470	53

INTRODUCTION

The **M550** family is the result of **IMET**'s many years' experience in the production of radio remote controls. **IMET** radio remote controls are advanced instruments designed and built using state-of-the-art technology.

IMET M550 radio remote controls are available in a large number of versions for any application. They are easy to install and they become an integral part of any machine that can be operated by remote control.

IMET radio remote controls come in many versions: simple units with single transmission and digital controls (ON/OFF), or more complex units with digital/analog controls, CAN-bus and dual transmission (data-feedback option).

The practical, ergonomic control panel lets you manage all machine functions and perform the most difficult operations from a safe position.

The units are easily identified by the ID code printed on the nameplate affixed to every unit. The meaning of the ID codes is shown in the tables on pages 5 and 6.

The casings are made of shockproof plastic to guarantee complete functionality even in the toughest operation conditions.

M550 portable transmitters are equipped with a removable, rechargeable sealed battery, ensuring continuous operation over long work shifts even in extreme environmental conditions.

The frequency synthesis radio section (PLL) lets you change the frequency of the transmission channel directly on the control panel.

Continuous, encoded radio transmission is used: the receivers are designed to recognize control signals coming from transmitters having the same ID code. Signals coming from other transmitters are ignored. . In the presence of interference, bad reception or interruption of the radio signal, the receiver automatically puts itself in stop status, that involves opening the E-STOP circuit (**clause 9.2.7.3 EN 60204-32**).

Every radio remote control is designed and built in conformity with the European Directives and with the relevant standards and can be used to set up a wireless control station complying with the strictest safety requirements.



1. Identification data

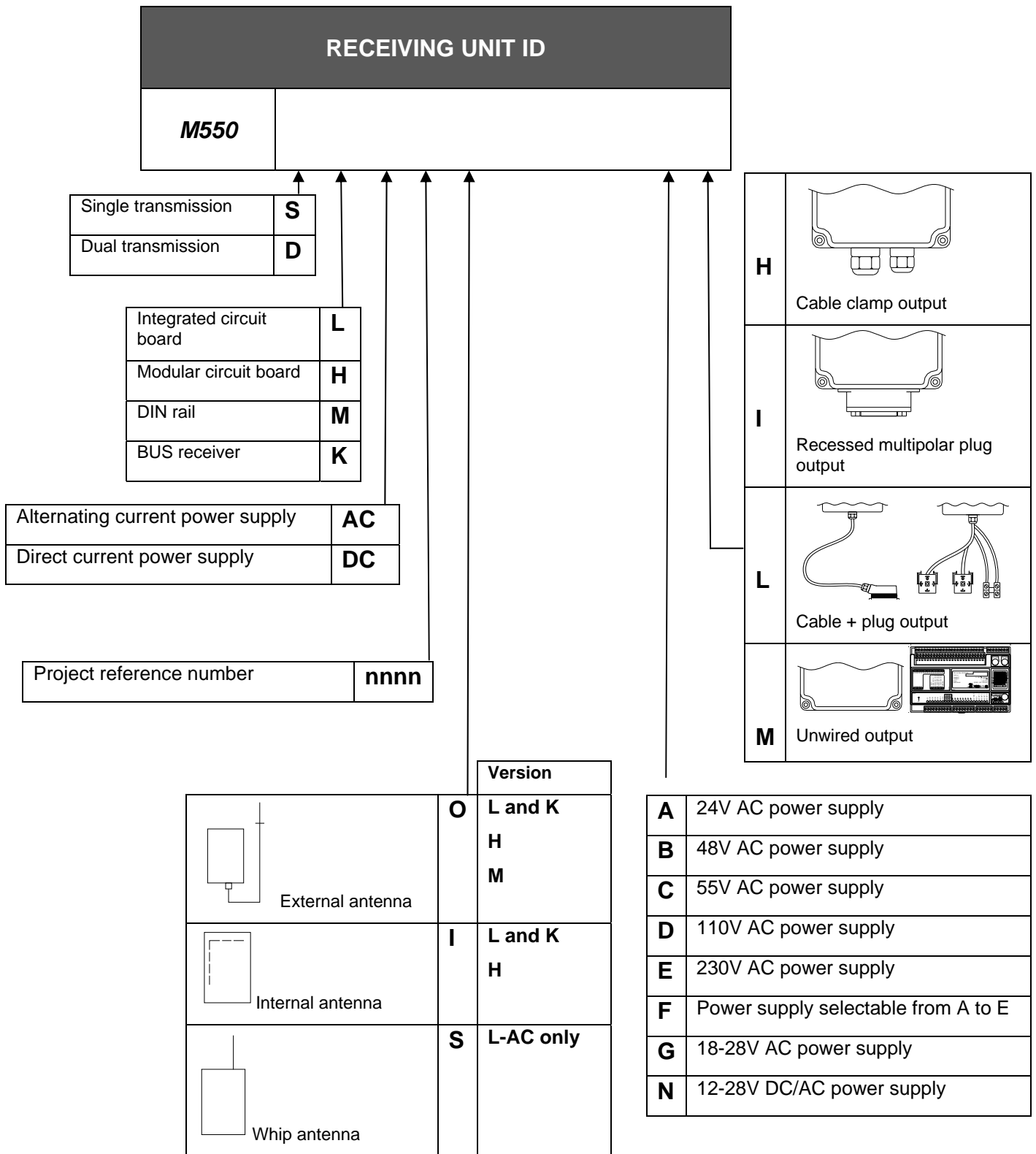

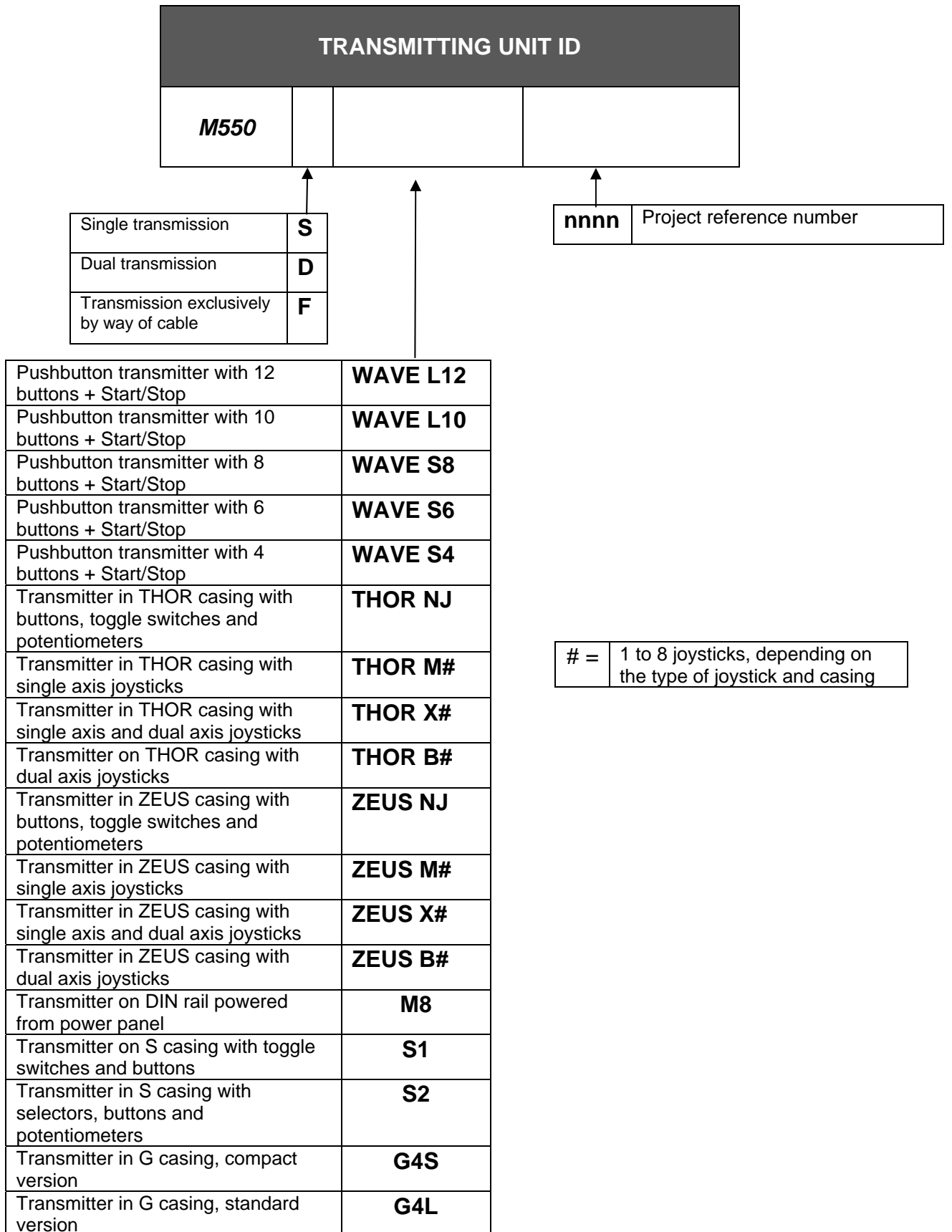

1.1. Documentation

All IMET radio remote controls are accompanied by the following documents:

- User's Manual (**the annexes are an integral part of the manual**)
- Warranty Certificate

If any documents are missing, please contact IMET and provide the unit's serial number.

2. CONVENTIONS USED IN THIS MANUAL



Warning: This symbol indicates instructions to be strictly followed for the radio remote control to work properly.



Danger: This symbol indicates important information on avoiding dangerous situations when using the radio remote control.



Note: This symbol indicates useful suggestions for the proper use of the radio remote control.

3. CAUTION



READ THE INSTRUCTIONS CAREFULLY BEFORE INSTALLING THE RADIO REMOTE CONTROL! FAILURE TO APPLY ANY OF THE PROCEDURES DESCRIBED IN THIS MANUAL MAY LEAD TO INJURIES TO PERSONS OR DAMAGES TO PROPERTY.

NO PART OF THE RADIO REMOTE CONTROL SHOULD BE USED AS A SPARE PART FOR OTHER RADIO REMOTE CONTROLS.

Follow the local laws on safety and workplace accident prevention. All the regulations on using radio remote controls for industrial machinery **MUST BE OBSERVED AT ALL TIMES.**

IMET accepts no responsibility for the unlawful use of the radio remote control.

3.1. Risk analysis

It is necessary to evaluate the risks, in order to establish the safety and health safeguard requisites concerning the machine with radio remote control use. A risk analysis must be carried out when deciding whether an application can be radio controlled. It should be carried out by qualified personnel, who assume all the relevant responsibilities.



IMET accepts no responsibility for failure to carry out a proper risk analysis.

A possible loss of communication between the transmitter and receiver, caused by disturbances or electromagnetic interferences, has to automatically block the radio command (clause 9.2.7.3 EN 60204-32). This implies a new procedure of starting the machine, so this blockage should be considered a foreseen condition

3.2. Applications

The most common radio remote control applications regard lifting or carrying apparatus such as tower cranes, bridge cranes, truck cranes and concrete pumps. Other applications are possible provided the following conditions are observed.

Do not use the radio remote control in environmental and electrical conditions other than those specified in Chap. 9. Do not use the radio remote control in environments that are required to be explosion-proof. The radio remote control should be installed by qualified personnel following the local regulations.

Keep this manual and the warranty certificate (filled out in every part) in a safe place.



4. PREVENTIVE MAINTENANCE

Before performing any maintenance operation, turn off the power to both the receiving unit and the machine and remove the battery from the transmitter.

- Do not expose to heat sources
- Avoid prolonged exposure to direct sunlight
- Do not wash with water under pressure or dip the device in water
- Avoid contact with oil or solvents
- If the device has been opened for any reason, make sure all the seals and gaskets are in place when closing

To keep you radio remote control in good working order, regularly clean it using a brush and a damp cloth. Do not use alcohol or solvents: they might damage the components and the casing.

4.1. Routine maintenance to be carried out by operator

Periodically clean the outside of the receiving and transmitting units. Dirt deposits can hinder the functioning of buttons, toggle switches and manipulators.

Apply special care to the STOP button, keeping it clean and making sure it works with no difficulty.

Remove any traces of oxidation from the battery contacts.

Check the casing and the components for cracks or apparent damages.

All rubber parts, buttons, seals and gaskets should show no sign of tearing.

Damaged components should be immediately replaced to prevent humidity or dirt from penetrating and jeopardizing the safe operation of the radio remote control.

4.2. Maintenance and internal checks

After every year of use we recommend carrying out a general inspection on the radio remote control (to be performed by qualified personnel).

Open the housings of the transmitting and receiving units and make sure:

- that the gaskets are in order
- that the cable clamps are efficient
- that the connection terminal screws and the connector couplings are tight
- that the electronic boards are securely fastened
- that the fastening screws of all components are tight

Although IP65 units are hermetically sealed, dust and humidity may accumulate over time when working in particular conditions. Carefully remove any foreign matter.

When closing the transmitting unit, apply special care to the casing's sealing, in order to prevent the infiltration of humidity.

Power on the device, being careful not to touch any live parts in the receiving unit, and perform the following tests:

- Check the functioning of all the controls.
- Verify that the STOP circuit intervened correctly. By pressing the STOP button, during operation, relay contacts A and B, of the E-STOP circuit must be opened
- Any broken parts must be replaced with original spare parts, in order to keep the characteristics of the radio remote control unchanged. See list of parts that can be replaced in Chapter 11



5. INSTALLING THE RADIO REMOTE CONTROL

We recommend following the instructions below to set up a properly operating radio remote control system.

The radio remote control should be installed by qualified personnel only.



Install the receiving unit, or its antenna, in case of versions with an external antenna, in the line of sight of the transmitting unit, with no electromagnetic shielding. To improve the operating range if the antenna is integrated, do not install the unit on metal surfaces, if possible.

Do not bypass the machine's safety systems; follow the manufacturer's instructions.

Do not install the receiving unit too high above the ground (10÷20 metres). At these heights the unit may receive local radio signals that can disturb transceiving operations.

To prevent water infiltrations, install the receiving unit vertically, with the cable clamps and any connections at the bottom, as shown in the figure.

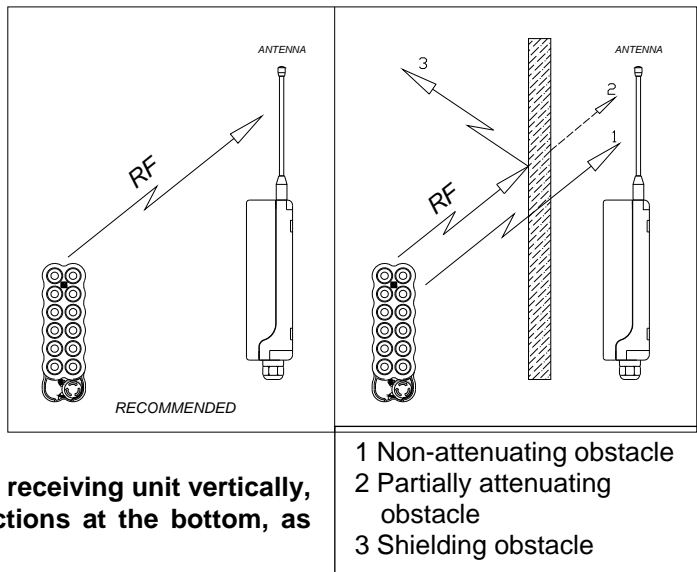

In case of strong mechanical vibrations, place a rubber shock-absorber between the machine and the receiver. (dampers).

M-AC receivers and M8 transmitters must be fastened to DIN rails inside a cabinet provided with a locked door preventing unauthorized access.

5.1. Receiving unit dimensions and drilling diagram

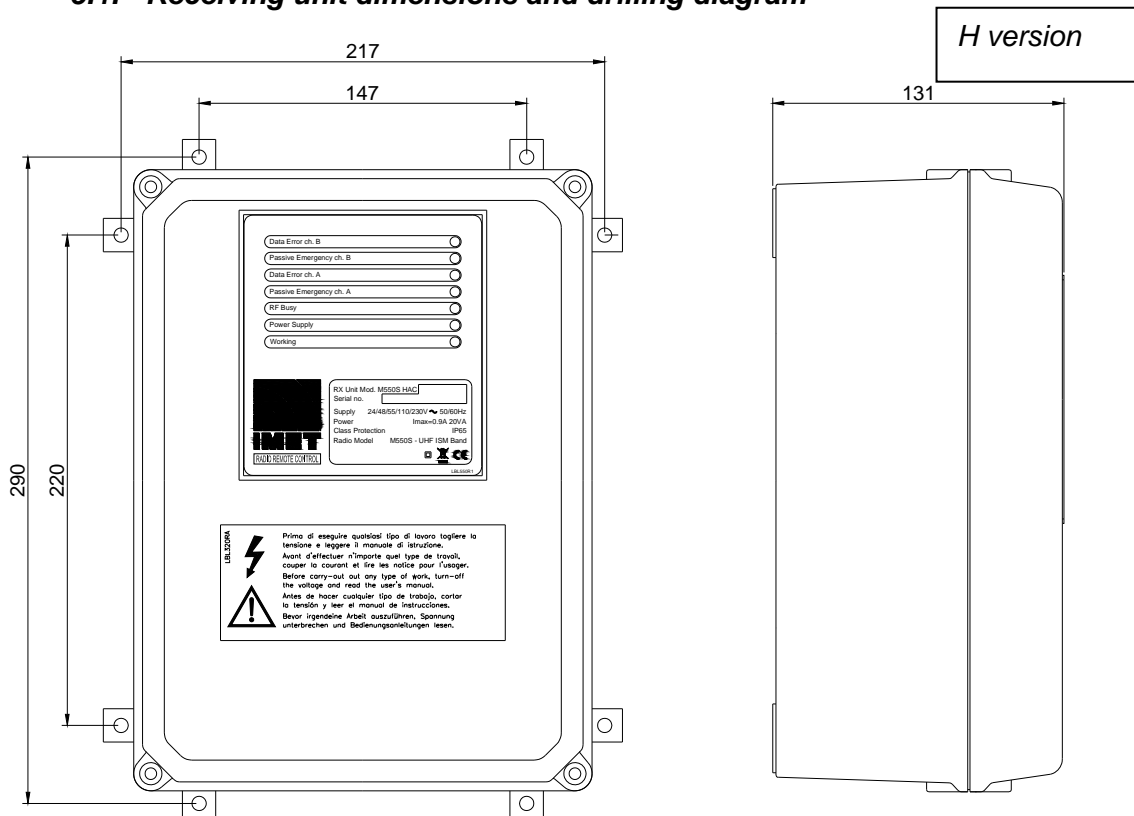

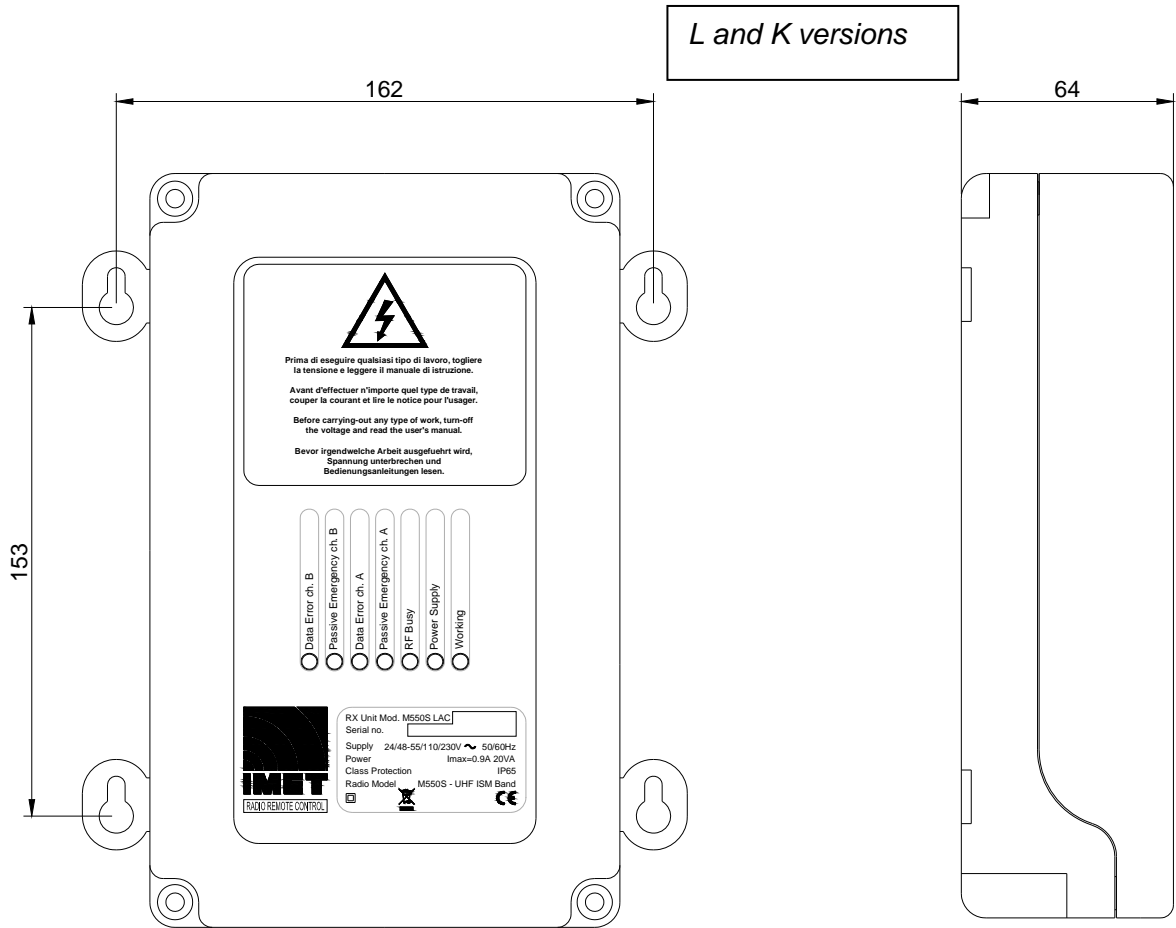

The dimensions correspond to 14 mod. DIN.

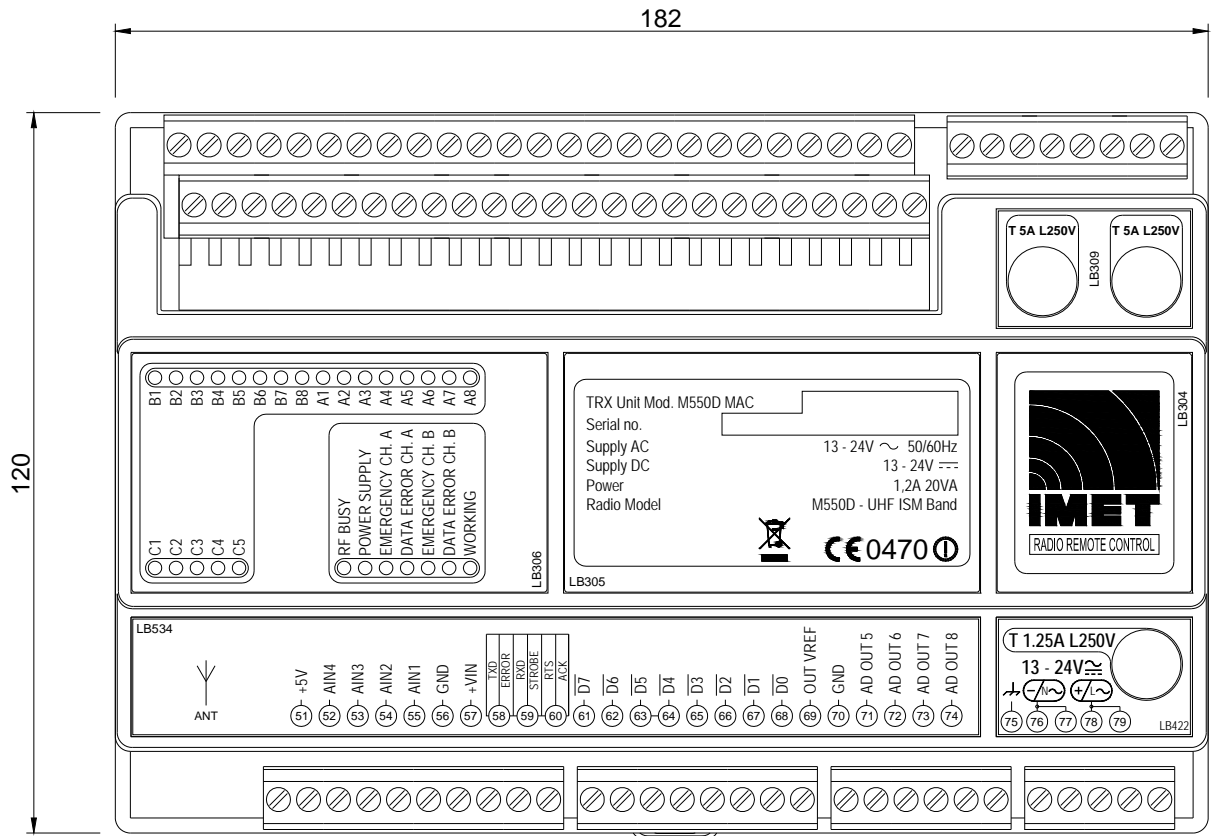



5.2. Connecting the receiver

Do not perform any operation until the equipment is powered off.

The power supply for the radio remote control should be located downstream from the machine's main switch.



Connecting to the distribution network directly is prohibited. The network disconnecting switch foreseen for the distribution network must be equipped with a device protecting from unauthorised closing (padlock)

The connection between the receiving unit and the machine should always be REMOVABLE. If the connection is made directly on the terminal board inside the machine, a multipolar connector should be used so that the receiver can be disconnected and the original wired controls restored at any time.

The wire connections between the receiving unit and the machine should respect Standard EN60204. The wires must have a cross-section of at least 0.75 mm² and must be self-extinguishing.

If possible use ferrules for conductor ends, and make sure that the terminals are fastened tightly.

Consult the transmitting unit controls diagram (Annex A) and the receiving unit wiring diagram to identify the equivalent actuators in the two units.

Be sure to note the supply voltage when connecting the receiving unit.

In versions H-AC and L-AC, the fuse current must be adjusted to the supply voltage.



After installing, test the radio remote control and the machine to make sure they work as expected. In addition, it is very important to make sure that the STOP circuit works properly. Pressing the STOP button during normal operation should make the contacts of relays A and B in the E-STOP circuit open.

Lastly, fill in the sheet showing the connection diagram between the receiving unit and the machine and write down the date of installation in the box on page 47 of this manual.

5.2.1. Installing the external antenna

A properly installed antenna is essential for a good operating range. Install the antenna outside at the highest and most visible point, far from metal structures. Use a tuned antenna only, and connect it to the receiver using an RG58 coaxial cable (impedance 50Ω). For M550S M8 and M550D M8 type transmitters only use the antennas supplied by IMET, other types of antenna must be approved in conformity to the ETSI EN 300 200-2 standard

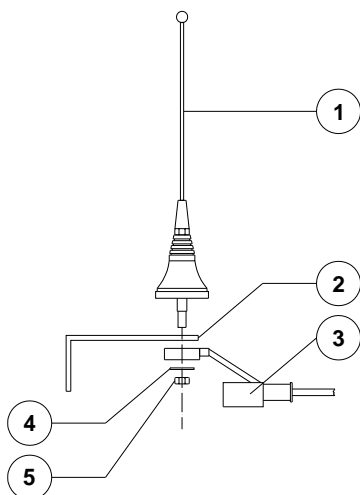

SYMBOLS

- 1 Antenna whip
- 2 Fastening bracket
- 3 RG58 cable with protective sheath
- 4 Washer
- 5 Locking nut

5.2.2. STOP (E-STOP)

Connect the contact of the E-STOP circuit so that it commands the coil of the machine's main line contactor, and remember that the maximum allowable current is 5A.



Attention: The E-STOP circuit has been designed for category 4 UNI EN 954-1 standard and/or PLe according to the ISO13849-1 standard. In order to keep this safety category, the relays must be connected in series (pre-cable standard configuration by IMET) or in parallel ONLY to manage interruption of the main power supply line (See Example 2).

5.2.3. Safety STOP (S-STOP)

The **Safety Stop** is an additional safety function. It consists in relay inside the receiver monitored by the RX logic that can be associated with the commands sent by the transmitter and which in case of problems automatically stops the receiver, as shown by the status LEDs.

Example 1 (in series to control commands): The Safety Stop introduces a redundancy which activates the safety function in case the control command relays fail to open.

Example 2 (operating the bypass valve): The Safety Stop can command the drain valve in a hydraulic machine so that the machine is powered only when a control command is given.

The Safety Stop must not be associated with the bistable selection controls

The risk analysis and safety class are based on Standard UNI EN 954-1 and ISO 13849-1 . The safety class of each control is shown in Annex B. Take good notice of the maximum currents allowable on the relay contacts (see Chap. 10).

Example of wiring of Safety-Stop relay for AC applications

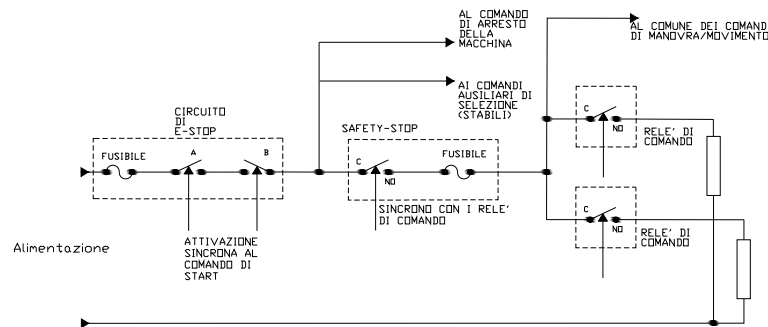

Alternative for special applications (for L-AC receivers only)

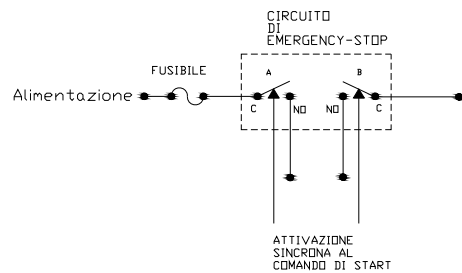

Example of wiring of Safety-Stop relay for DC applications

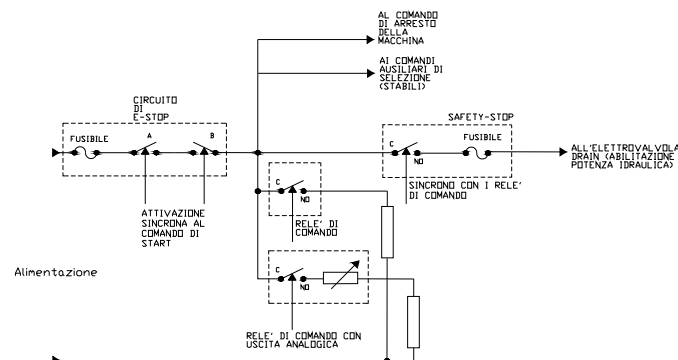

5.3. Basic functions

The table below shows the basic functions available on almost all receivers.

Relay	Function	Typical Uses	Remarks
T-STOP	The relay is activated for 5 seconds from the moment the radio remote control is switched off or enters passive emergency mode. The T-STOP can be activated at switch-off or with a 2 second delay.	<ul style="list-style-type: none"> Delayed STOP of combustion engine Engine deceleration 	
S-STOP	The relay is activated only by an instable command from a toggle switch, button or joystick Connected in series , the function introduces a redundancy that can be used to increase function safety	<ul style="list-style-type: none"> Enables the drain valve Common enabling of control commands 	Relays constantly monitored by uP. Opens with a 0.8 second delay
E-STOP	The two relays are activated when the radio remote control is switched on (STOP RELAY cat. 4 UNI EN954-1 e PL e ISO13849-1) and stay active until a STOP command intervenes (pressing the STOP button or passive emergency)	<ul style="list-style-type: none"> Powers the main contactor in the machine's control box Common power supply for control commands Machine power supply 	Relays constantly monitored by uP
HORN	Horn control relay	Warns of potentially hazardous situations	it can be associated to the first START
START	START control relay	Powers the machine's control box and enables machine Start function	
LAMP	Blinker control relay	Blinker power supply	

5.4. Connection diagrams of H receivers

Receiving unit version H is provided with 7 slots where the control relay cards, the analogue output cards and the data feedback card are plugged in. Slot A includes, as well as the group A controls, the basic functions in the table above.

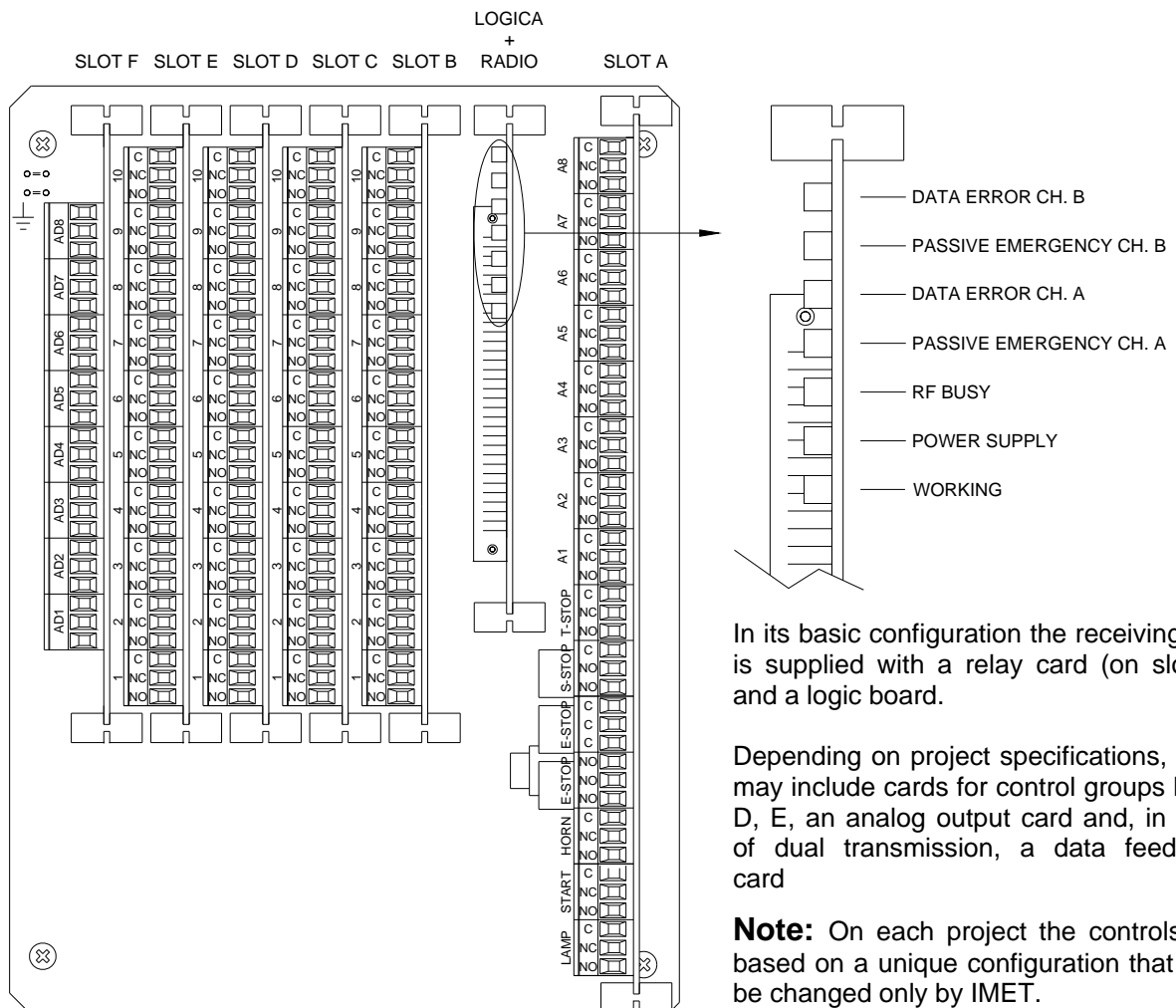

5.4.1. H receiver with analog output card and data feedback card

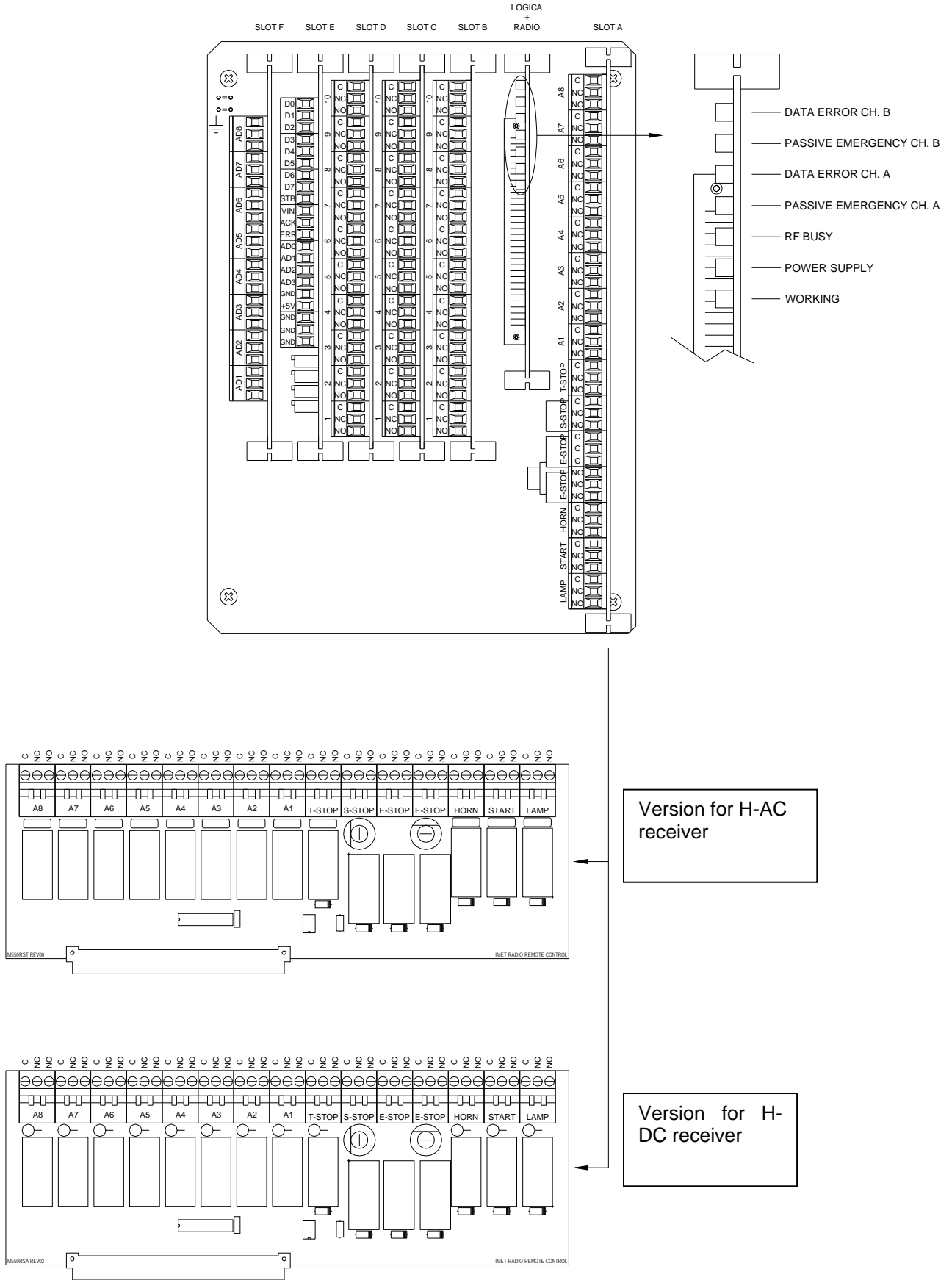

5.4.3. Analog command card

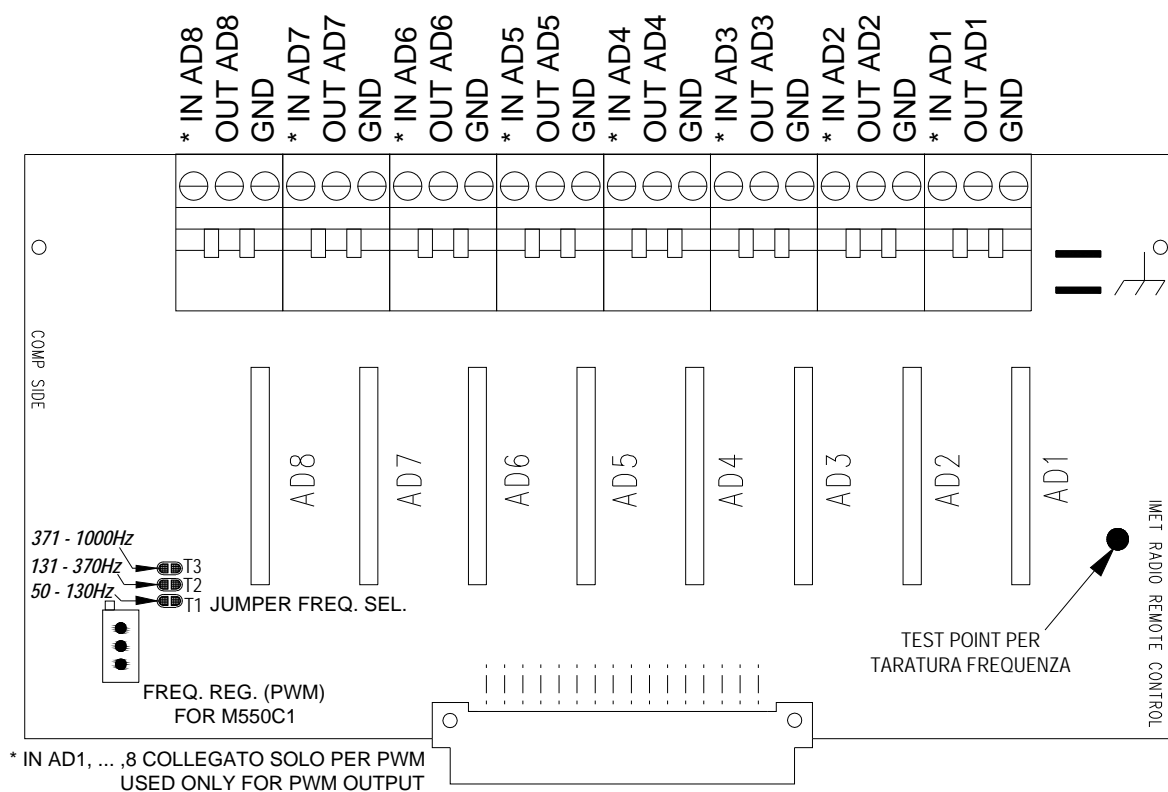

Control modules

M550C2: 0-20mA/4-20mA current-operated control

M550C1: PWM current-operated control

M550V: voltage-operated control

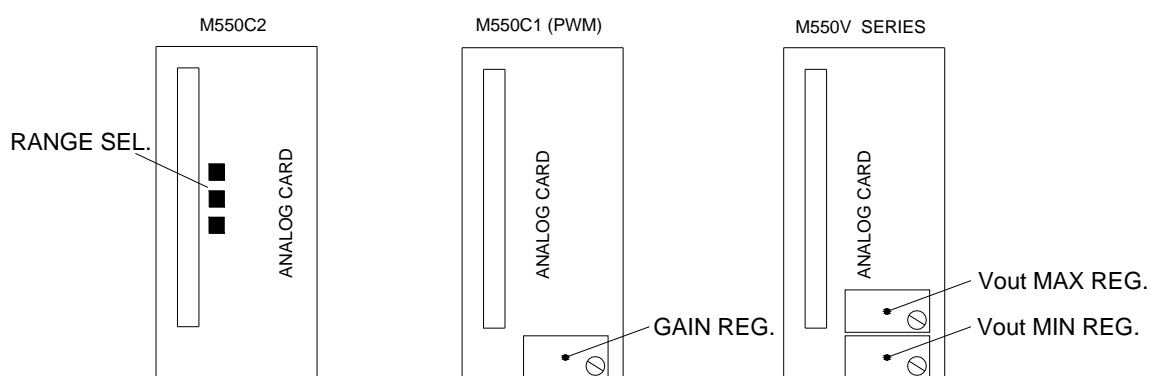

5.4.4. Logic board

The logic board receives and decodes the commands coming from the transmitting unit. The board is preset for an (optional) serial connection to the transmitting unit for receiving data via cable.

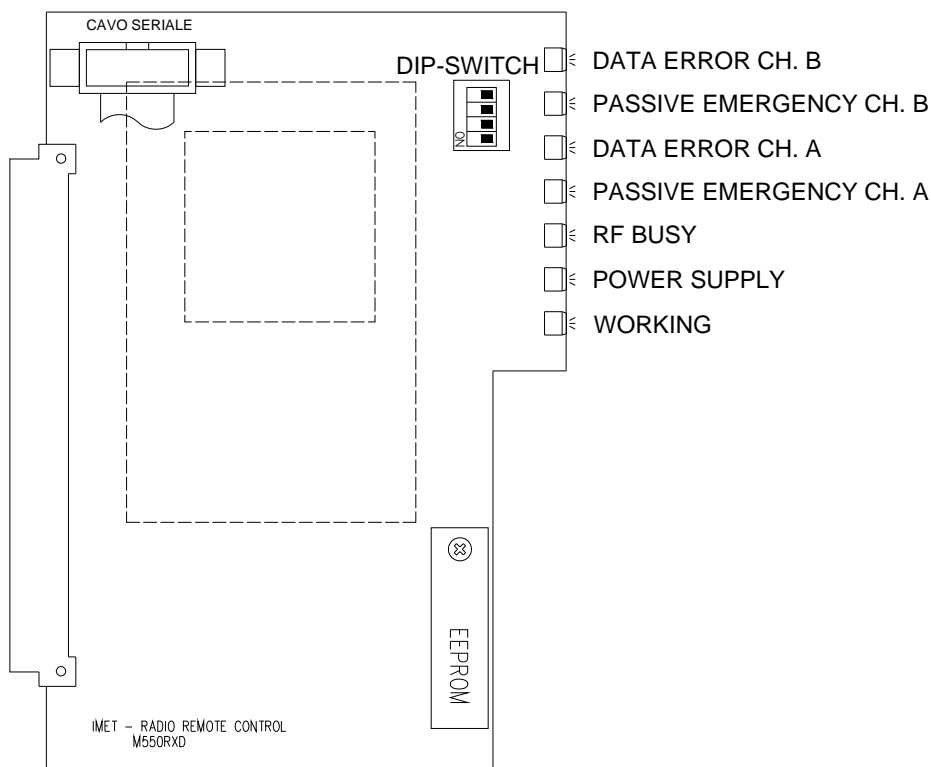

5.4.5. Data feedback card

The data feedback card is used when it is necessary to collect data from the application and send it via radio to the display on the transmitting unit. Data collection can be performed in parallel or in series, as shown in the table below.

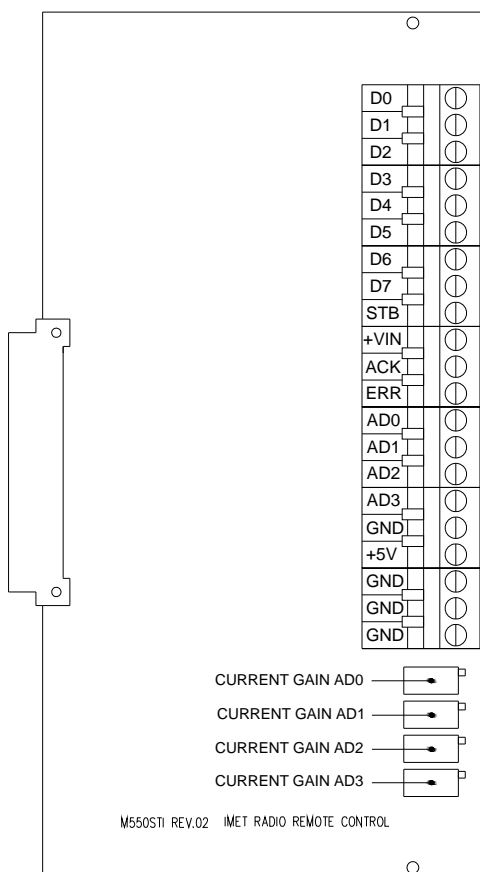

Option	Terminal	Description
USER SERIAL	STB	RS232 user input
PARALLEL	D0,...,D7	Optoisolated parallel port digital inputs
	STB	Parallel port control I/O
	VIN=ENABLE	Input enabling the ACK and ERR outputs
	ACK	Parallel port control I/O
	ERR	Parallel port control I/O
	AD0,...,AD3	12 bit A/D converter inputs
	+5V	Auxiliary power supply output (Imax = 5mA)
	GND	Ground connection inputs
	CURRENT GAIN AD0-AD3	Current amplification regulator for AD0-AD3 input signal

5.4.6. Relay control cards

The following control cards can be mounted on the free slots, depending on the user's requirements. The cards are available in versions with 8 or 10 relays.

Version for H-AC receiver

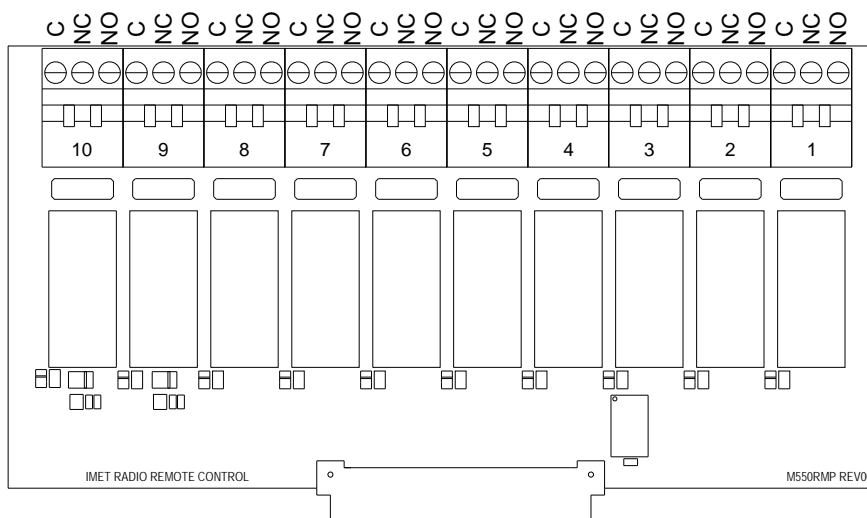

Version for H-DC receiver

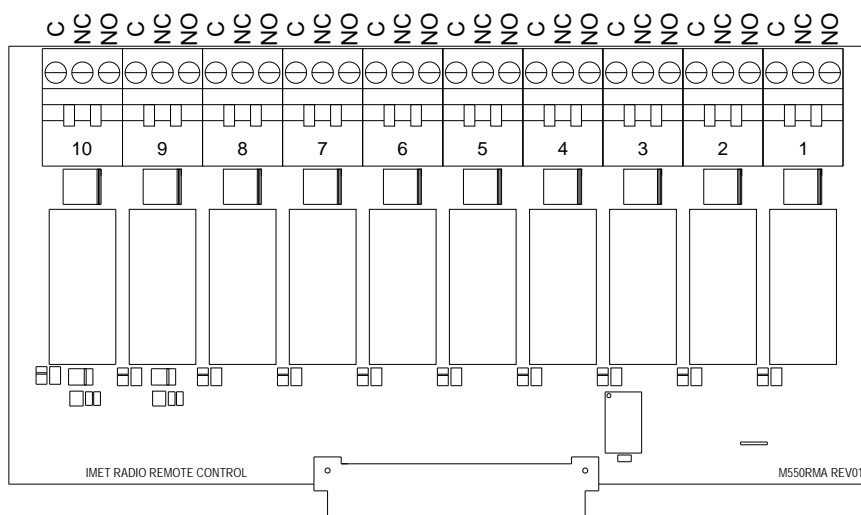

5.4.7. Potentiometer card

Used for controlling tower cranes. The potentiometer card lets you set the operating speeds independently.

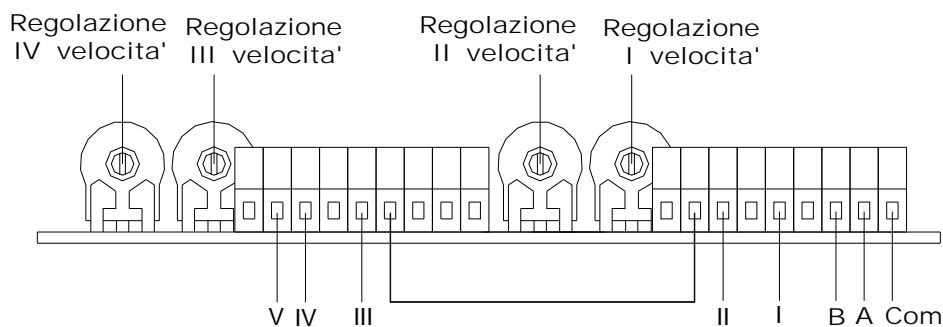

5.5. Connection diagrams for L and K receivers

L and K receiving units are equipped with 1 slot that can be used for:

1 card with relay outputs for AC or DC versions or, alternatively

1 card with MOSFET outputs + 1 card with analog outputs for DC versions only

The safety controls and the basic functions are located directly on the motherboard, as shown in the table in Chap. 5.3.

5.5.1. L-AC Version

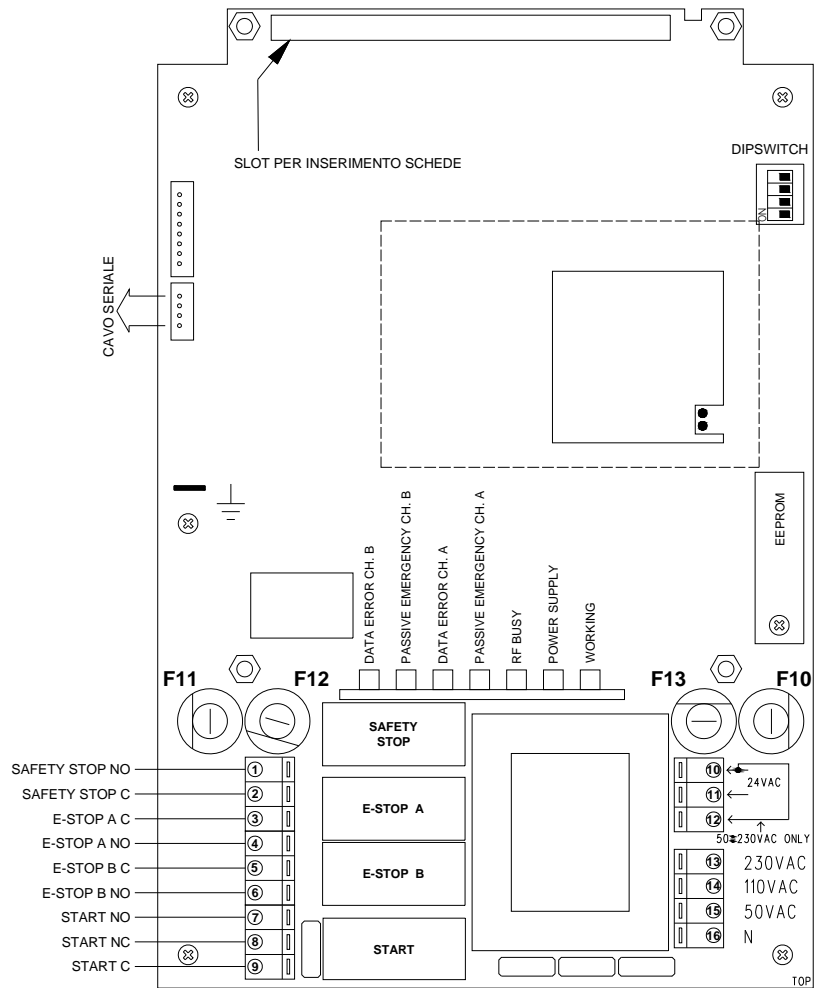

Options on request	SYMBOL	DESCRIPTION
	N	Neutral for main power supply 50/110/230V AC
	50V AC	Input for 48-55V AC power supply
	110V AC	Input for 110V AC power supply
	230V AC	Input for 230V AC power supply
	50-230V AC ONLY	Connection for power supplies from 48V AC to 230V AC MUST BE DISCONNECTED IN CASE OF 24V AC POWER SUPPLY
	24V AC	Input for 24V AC power supply
	F13	T80mA L250V with 230V AC power supply
	F13	T200mA L250V with 110V AC power supply
	F13	T315mA L250V with 48-55V AC power supply
	F10	T1.25A L250V power supply fuse
	S-STOP	Safety-Stop relay connection
	F11	T5A L250V S-STOP contact protection fuse
	E- STOP	Emergency-Stop contact
	F12	T5A L250V E-STOP contact protection fuse
	START	NO/NC relay output
SERIAL CONNECTION CABLE	D0	DATA IN for RS232 serial
	VIN=ENABLE	Input enabling RS232 (down active)
	+10,7	10.7V DC I _{max} =250mA auxiliary voltage output
	GND	Ground connection input

5.5.2. L-DC version

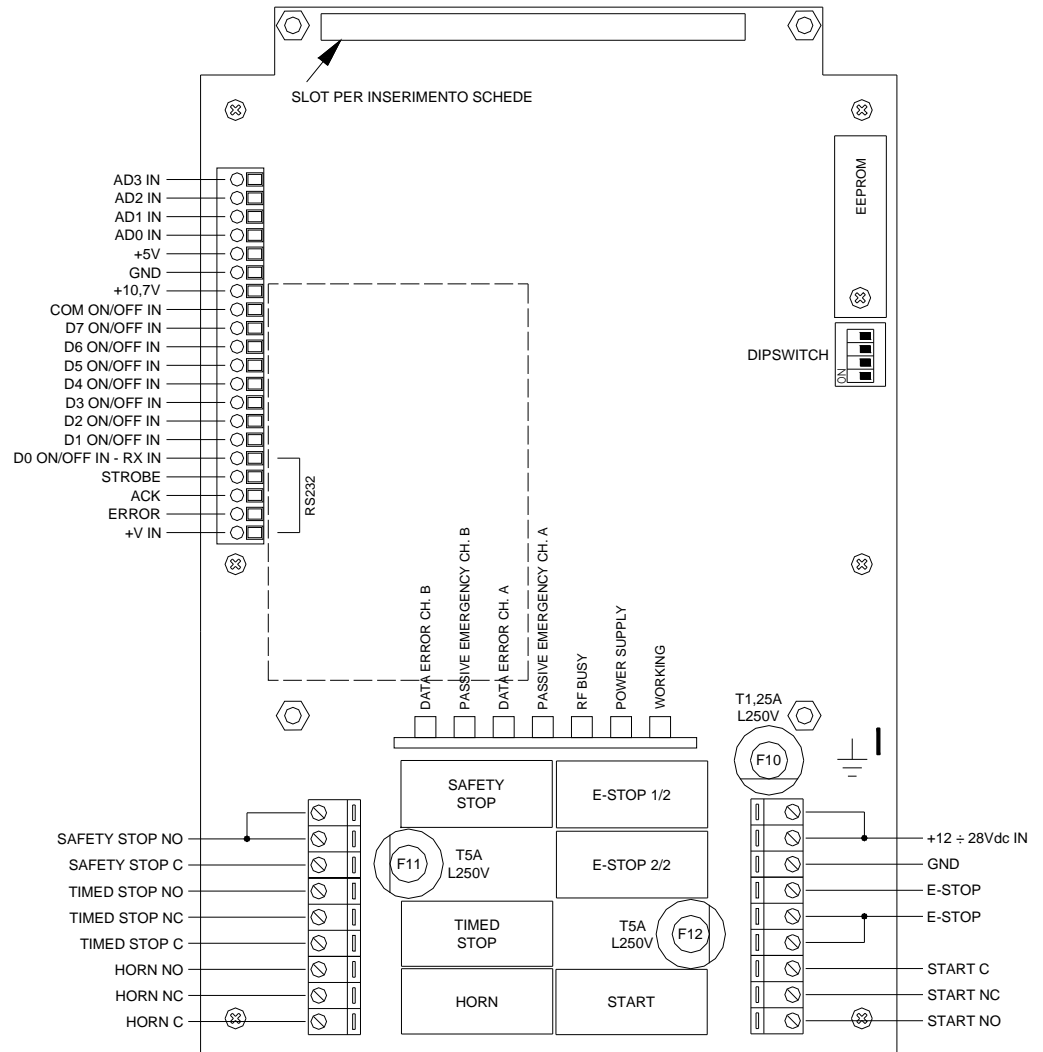

Options on request	SYMBOL	DESCRIPTION
	12-28V DC IN	Input for main power supply
	GND	Ground connection input
	F10	1.25A L250V power supply fuse
	E-STOP	STOP relay connection
	F12	T5A L250V E-STOP contact protection fuse
	START	NO/NC relay output
	HORN	Horn control relay output
	T-STOP	Time-Stop relay connection
	S-STOP	Safety-Stop relay connection
	F11	T5A L250V S-STOP contact protection fuse
SERIAL CONNECTION CABLE	D0	DATA IN for RS232 serial
	VIN=ENABL	Input enabling RS232 (down active)
	E	
	+10,7	10.7V DC I _{max} =250mA auxiliary voltage output
	GND	Ground connection input

5.5.3. K version

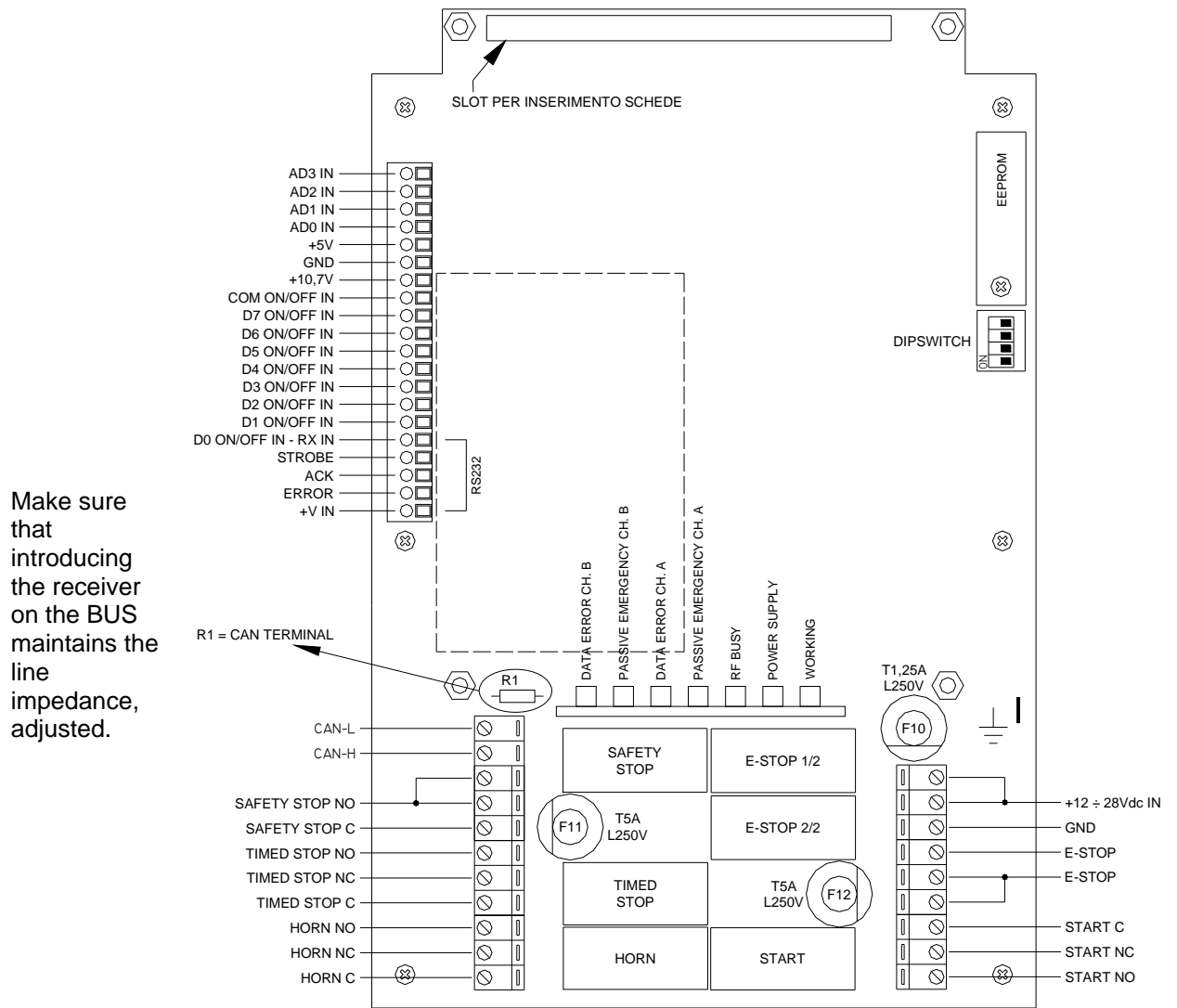

Options on request	SYMBOL	DESCRIPTION
	POWER IN	Input for main power supply
	GND	Ground connection input
	F10	1.25A L250V power supply fuse
	E- STOP	STOP relay connection
	F12	T5A L250V E-STOP contact protection fuse
	START	NO/NC relay output
	HORN	Horn control output
	T-STOP	Time-Stop relay connection
	S-STOP	Safety-Stop relay connection
	F11	T5A L250V S-STOP contact protection fuse
	CAN-H	CAN-H line input
	CAN-L	CAN-L line input
SERIAL CONNECTION CABLE		
	D0	DATA IN for RS232 serial
	VIN=ENABLE	Input enabling RS232 (down active)
	VOUT 10.7	10.7V DC I _{max} =250mA auxiliary voltage output
	GND	Ground connection input

5.5.4. Relay control cards for L and K receivers

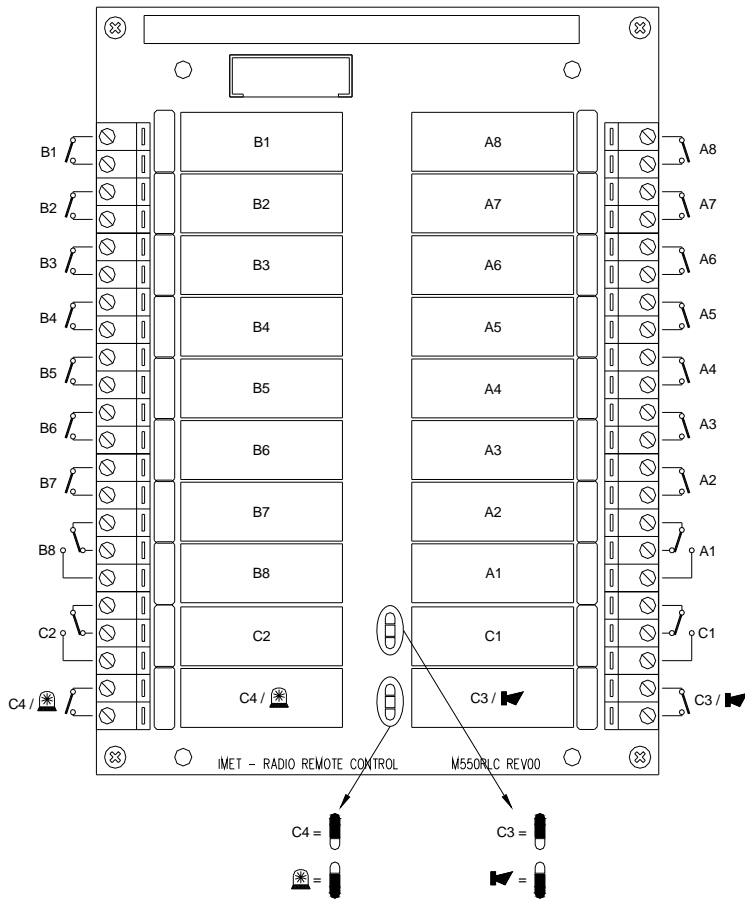

Version for L-AC receiver

Relays C3 and C4 can be configured for the horn and the blinker by closing the contacts on the respective jumpers.

Version with 12A relays for L-DC and K-DC

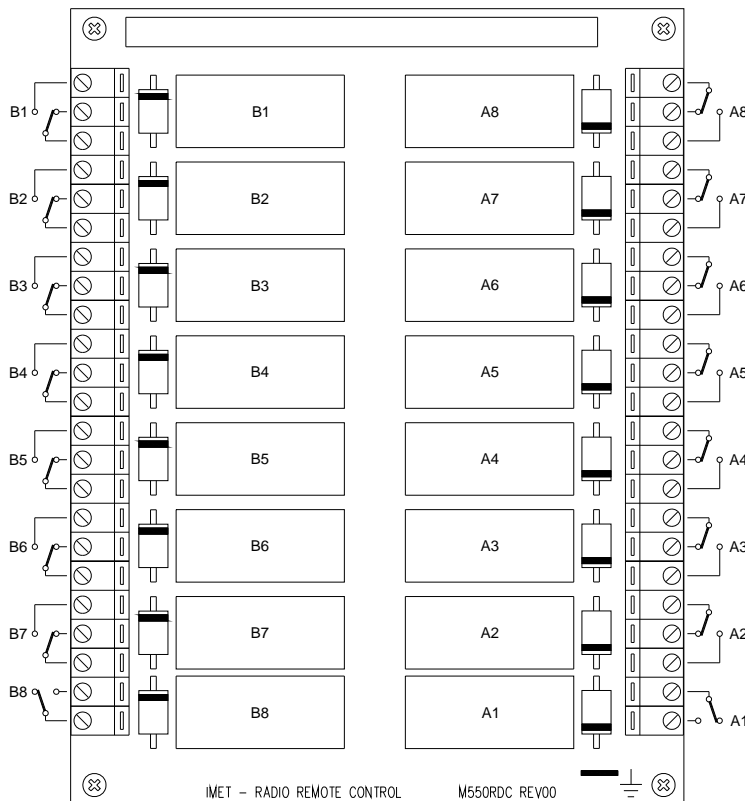

Version with 16A relays for L-DC and K-DC

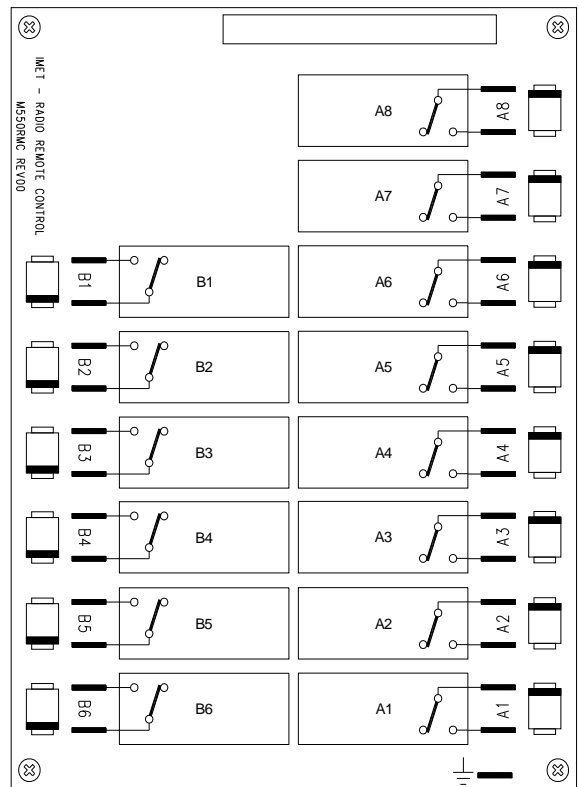

5.5.5. Other control cards for L-DC and K-DC receivers

MOSFET control card

Mosfet + analogue command board for HSC

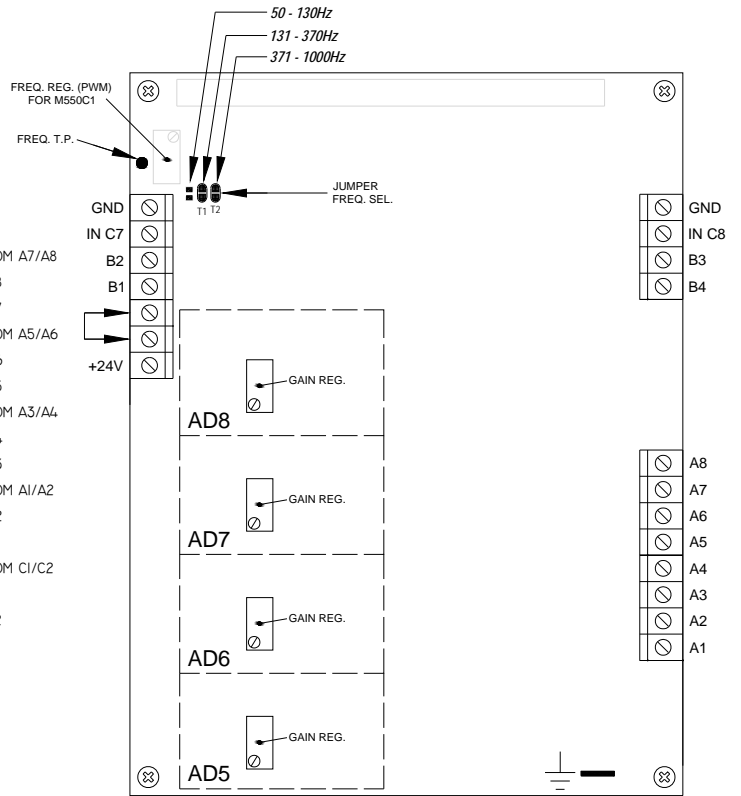
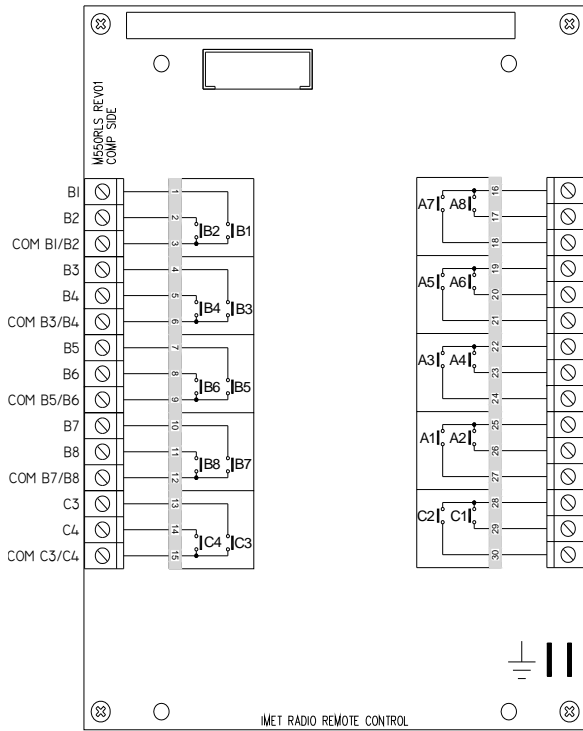

Analogue control card

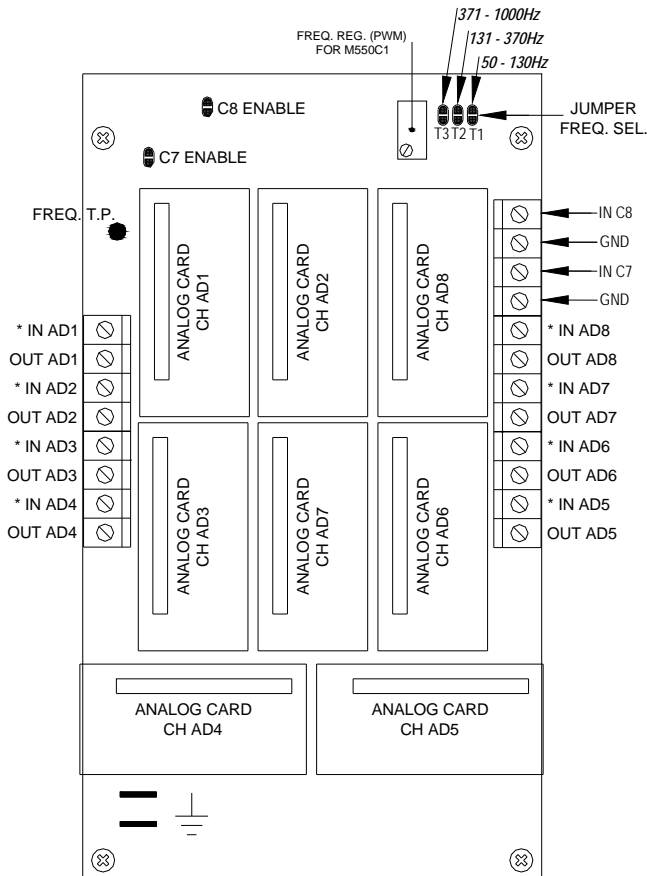

Control modules

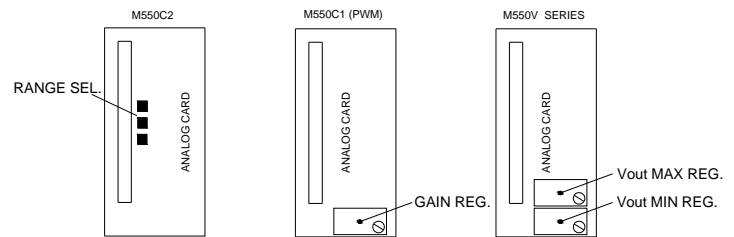

M550C2: 0-20mA/4-20mA current-operated control

M550C1: PWM current-operated control

M550V: voltage-operated control

* IN AD1... 8 COLLEGATO SOLO PER PWM
- UNICO ADIUTTO PER INPUT

5.6. Serial data transmission

The radio remote control is preset for optional serial data transmission and acquisition.

5.6.1. User serial (RS232)

This connection is used with transceiving applications to receive data from an external device and to send data to the transmitter's display.

The following messages can be sent:

- **Messages stored in the application's memory**

The messages must be sent to the RS232 connection in data packets following the serial protocol shown below. The application must send the data feedback card the single characters that make up the message to be shown on the display of the transmitting unit.

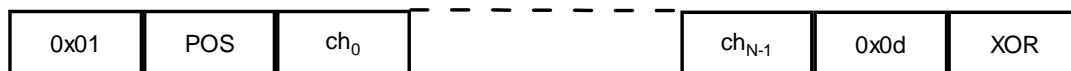

Ordine di invio →

BYTE	Description
0x01	A variable indicating the start of the message.
POS	Position of the message's starting point on the display.
Ch ₀ ...Ch _{N-1}	Generic i th character sent to the display (text of message).
0x0d	A variable indicating the end of the message. The variable is a hexadecimal value different from any ASCII character that can be shown on the display.
XOR	XOR of all the preceding bytes starting from 0x01 (parity check).

- **Messages stored in the data feedback card's memory**

In this case the application sends an N code to the data feedback card regarding the message (N) to be sent and shown on the display of the transmitting unit.

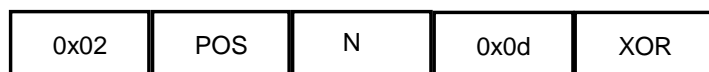

Ordine di invio →

BYTE	Description
0x02	A variable indicating the start of the message.
POS	Position of the message's starting point on the display
N	Number of the message stored in the card data feedback card.
0x0d	A variable indicating the end of the message. The variable is a hexadecimal value different from any ASCII character that can be shown on the display.
XOR	XOR of all the preceding bytes starting from 0x01 (parity check).

5.6.2. Serial connection cable

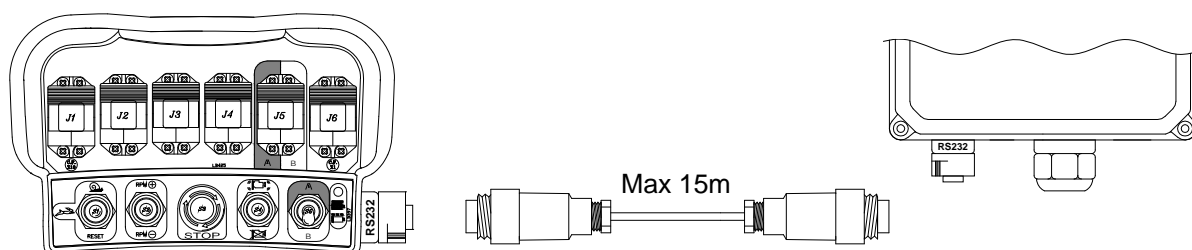

This option is used to transmit actuation command data via cable from the transmitter to the receiver and vice versa in case of dual transmission radio remote controls. The serial connection cable excludes radio frequency transmission and the receiver provides the power for the transmitter. After using the serial cable with the radio remote control, disconnect the cable and switch off the transmitter and the receiver to restore radio operation.

5.7. Connection diagrams for M-AC receivers

M receivers are designed for industrial applications and come in 4 standard versions:

Version S: single transmission

Version D SPP: dual transmission with data acquisition via parallel port

Version D RS232: dual transmission with data acquisition via RS232 serial port

Version D RS485: dual transmission with data acquisition via RS485 serial port

The safety controls and the basic functions are located directly on the motherboard, as shown in the table in Chap. 5.3.

Attention: with AC power supply it is MANDATORY to insert a transformer with double isolation or with reinforced isolation, between the main power supply of the control box and the receiver (available upon request)

5.7.1. M-AC receiver

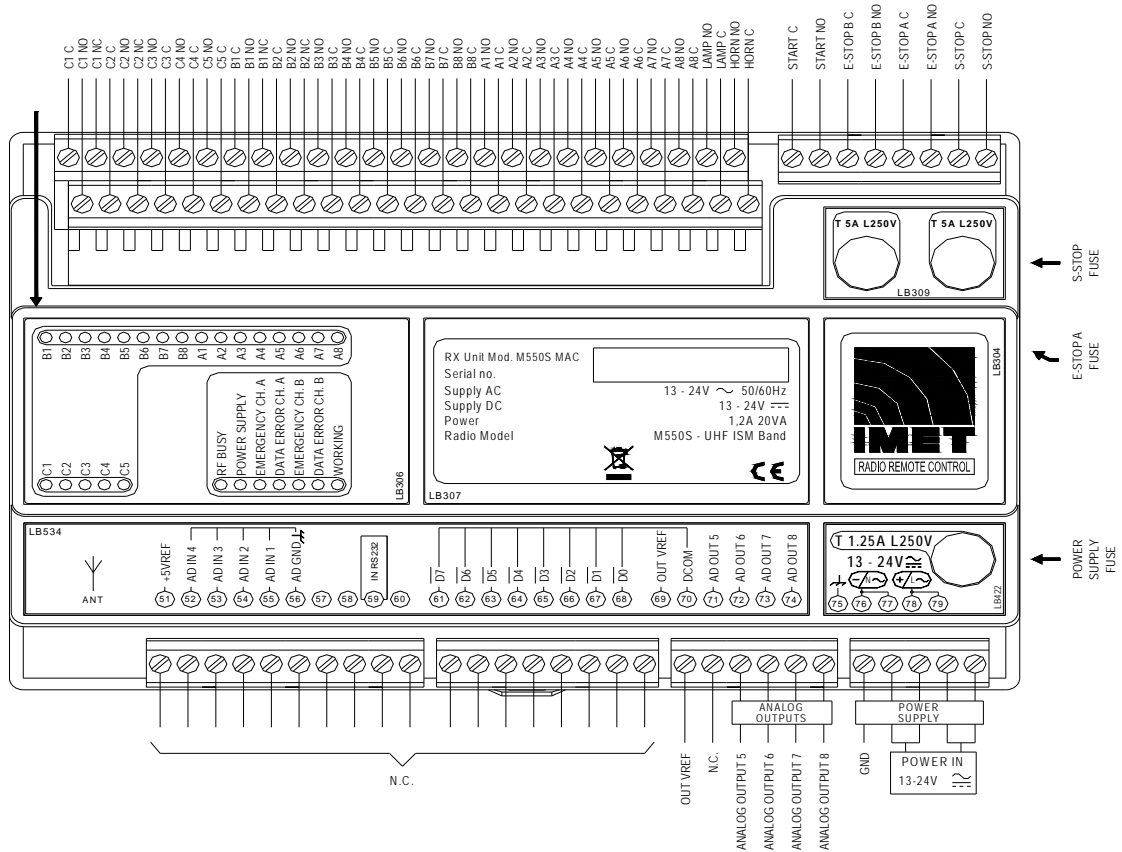

SYMBOL	DESCRIPTION
START	NO relay output
E- STOP A	STOP relay connection
E- STOP B	STOP relay connection
S-STOP	Safety-Stop relay connection
E-STOP FUSE	T5A L250V E-STOP contact protection fuse
S-STOP FUSE	T5A L250V S-STOP contact protection fuse
HORN	Horn control output
LAMP	Blinker control output
A1....A8	NO relay control output
B1....B8	NO relay control output (outputs B1 and B2 with NO/NC contacts)
C1....C5	NO relay control output (outputs C1 and C2 with NO/NC contacts)
ANT	SMA connection for antenna cable
GND	Common line for input and output signals
POWER IN	Input for main power supply
POWER SUPPLY FUSE	T1.25A L250V power supply fuse
ANALOG OUTPUT 5-8	Analog data outputs
OUT-VREF	10.7V DC I _{max} =250mA auxiliary voltage output

5.7.2. Common connections on M-AC transceivers

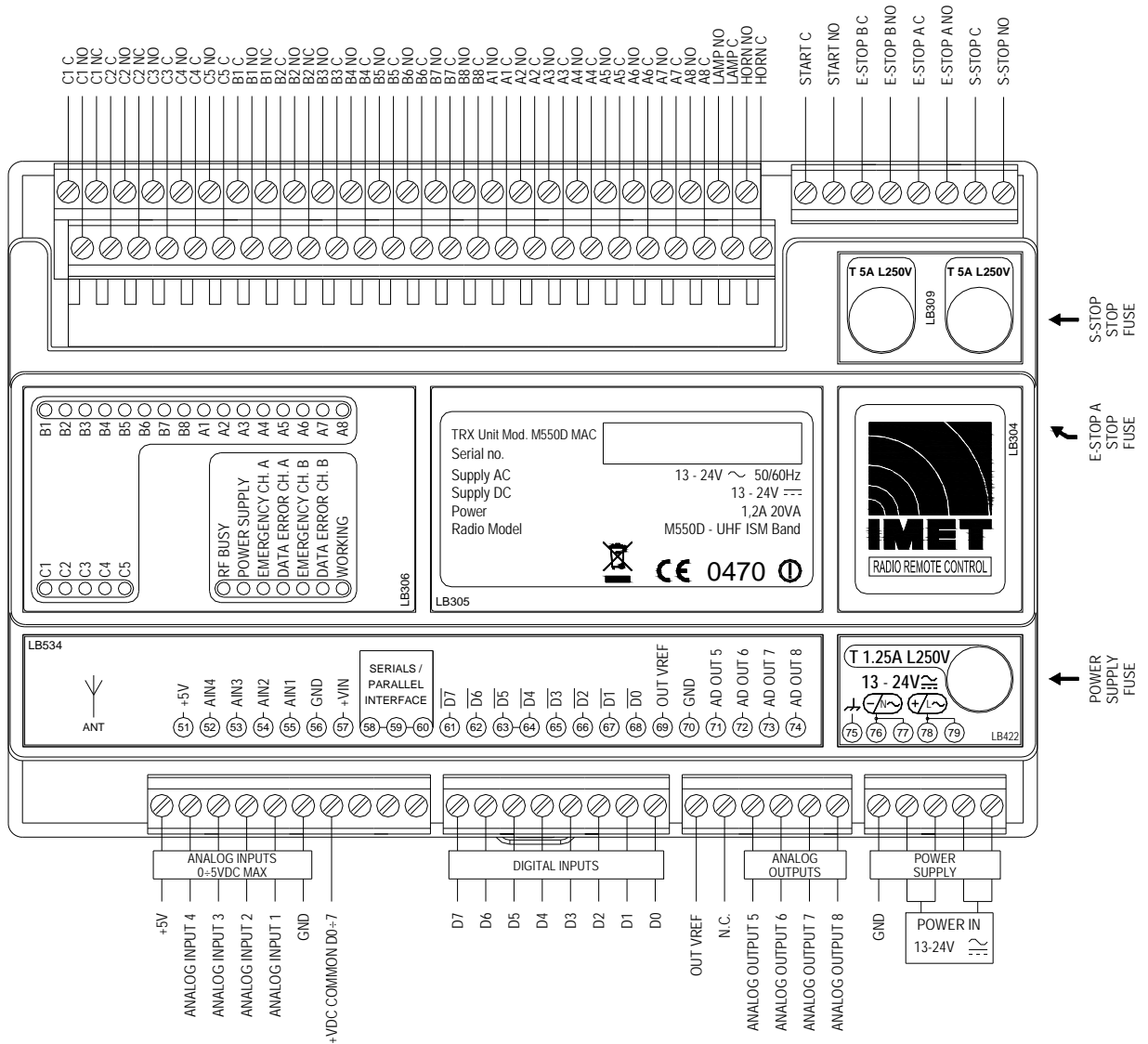

SYMBOL	DESCRIPTION
E- STOP A / ESTOP B	E-STOP A and E-STOP B connection
S-STOP	Safety-Stop relay connection
START	NO relay output
HORN	Horn control output
LAMP	Blinker control output
A1....A8	NO relay control output
B1....B8	NO relay control output (outputs B1 and B2 with NO/NC contacts)
C1....C5	NO relay control output (outputs C1 and C2 with NO/NC contacts)
GND	Common line for input or output signals
ANT	SMA connection for antenna cable
ANALOG INPUT 1-4	Analog data inputs
+5V DC	5V DC I _{max} =1mA output
D0-D7	(Optoisolated) V _{max} 30V DC digital data inputs
OUT-VREF	10.7V DC I _{max} =250mA auxiliary voltage output
ANALOG OUTPUT 5-8	Analog data outputs
POWER IN	Input for main power supply
POWER SUPPLY FUSE	1.25A L250V power supply fuse
E-STOP FUSE	5A L250V E-STOP contact protection fuse
S-STOP FUSE	5A L250V S-STOP contact protection fuse

5.7.3. M-AC transceivers: data acquisition connections

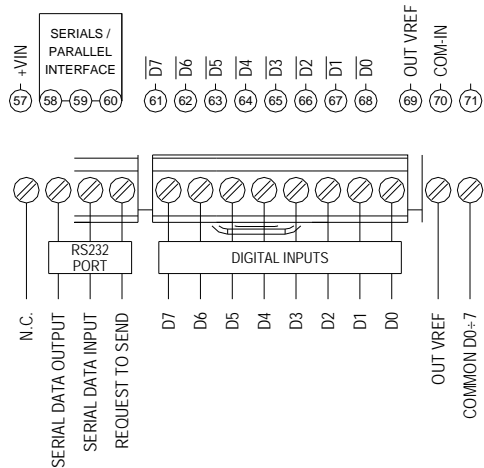

DATA ACQUISITION VIA RS232 PORT	
SYMBOL	DESCRIPTION
NC	Not connected
SERIAL DATA INPUT	RS232 serial user input
SERIAL DATA OUT	Not connected
REQUEST TO SEND	Not connected
D0...D7	Digital inputs
COMMON D0-D7	D0...D7 common input

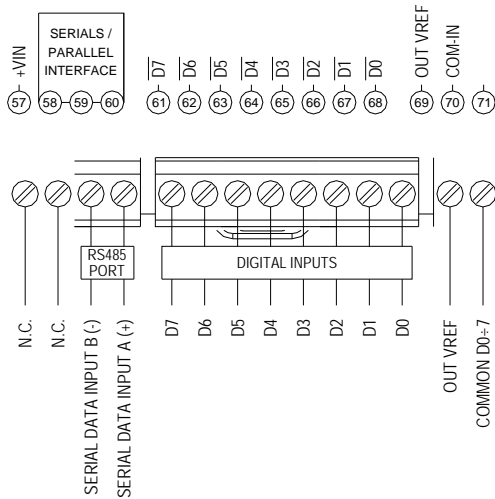

DATA ACQUISITION VIA RS485 PORT	
SYMBOL	DESCRIPTION
NC	Not connected
NC	Not connected
SERIAL DATE INPUT B (-)	Differential input for receiving data via RS485
SERIAL DATE INPUT A (+)	Differential input for receiving data via RS485
D0...D7	Digital inputs
COMMON D0-D7	D0...D7 common input

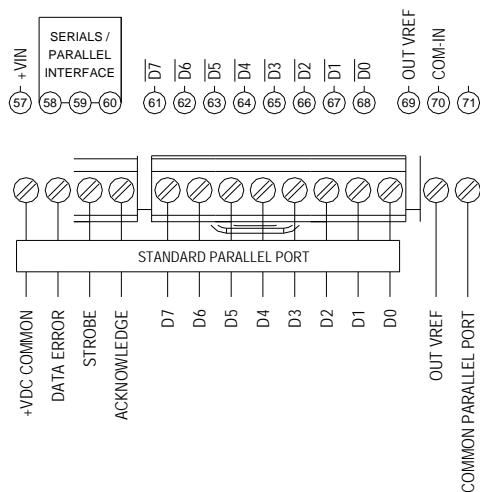

DATA ACQUISITION VIA PARALLEL PORT	
SYMBOL	DESCRIPTION
+VDC COMMON D0-D7	Input for enabling ACKNOWLEDGE and DATA ERROR digital outputs and parallel port power supply
DATA ERROR, ACKNOWLEDG E	Parallel port control output
STROBE	Parallel port control input
D0...D7	Parallel port inputs
COMMON D0-D7	Parallel port common input

6. USING THE RADIO REMOTE CONTROL

Use of the radio remote control following the safety precautions below to ensure safety at work.



6.1. Safety rules

The radio remote control should be used only by competent personnel with a thorough understanding of the remote control and of the machine controlled. All the persons using the radio remote control should be adequately instructed.

Do not turn on the transmitting unit if the controlled machine is not completely visible. If the transmitting unit is used in a closed area or far from the receiving unit, the operator cannot be fully aware of the movements of the controlled machine. This can lead to hazardous situations.

Whenever work is suspended, even if for short periods, turn off the control unit and remove the key from the transmitter to prevent unauthorized use.

6.2. Powering and starting the radio remote control

Initial conditions

- Transmitting unit off.
- Load a charged battery in the transmitter (except for M8 DIN units).
- **Make sure the mushroom-head STOP button is not pressed and that no control is in the working position.**
- Power on the machine and the receiving unit.
- Wait 2 seconds for the receiver to carry out the safety checks. If the checks are successful, the red "Passive Emergency Stop A and B" LED and the green Power Supply LED will stay on.
- To enable the transmitter, introduce the magnetic key or, on G4 units, turn the keylock switch clockwise.
- Press the Start button for one second. The green light on the transmitter should turn on and remain steady, meaning the unit is working properly. On the receiver, the red LEDs will turn off, while the yellow "Data Error A and B" LEDs and the green "RF Busy" and "Working" LEDs will turn on. The radio remote control is now ready to work.
- **The safety class of the each control is shown in Annex B.**

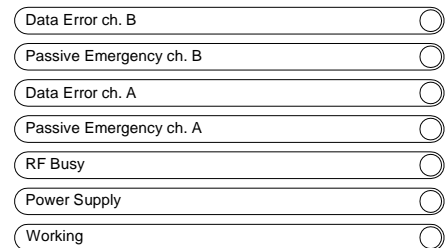

6.3. STOP

Press the red mushroom button. This will open the STOP circuit on the receiving unit and disable all the controls. To restore operations, reset the STOP (ISO 13850) button and press START.

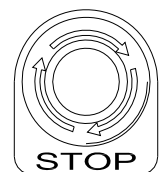

6.4. Turning off the remote control

Remove the magnetic key or, on G4 units, turn the keylock switch anticlockwise. The transmitter will turn off, the safety circuits will open and all active controls will be disabled.

The transmitting unit also turns off when the battery runs down completely. In this case, the LED on the transmitter will flash rapidly after shutdown.

6.5. Auto power-off

On request, the auto power-off time can be set to a maximum of 45 minutes, by 3-minute steps.

Transmitting units M550S M8 and M550D M8 switch off automatically after 20 hours of work to perform automatic tests on safety systems as required by Standard EN 954-1.

Upon explicit request by customers (and under their own responsibility), the auto power-off function can be excluded. In this case the STOP circuit is downgraded to category 3 or PLd.



6.6. Meaning of LEDs

The radio remote control is provided with LEDs (light-emitting diodes) that provide the following information:

- Operating status
- Operating malfunctions
- Type of malfunction
- Battery exhausted (except M8)

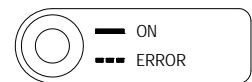

M8

Transmitting Unit	
LED status	Meaning
Off	<i>Transmitter off or malfunctioning (see Chap. 8)</i>
On	<i>Transmitter working.</i>
Flashing at regular intervals	<i>Battery exhausted (except M8)</i>
Flashing with regular number of flashes	<i>Transmitter is in analog output calibrating mode (see the manual on calibrating the analog outputs)</i>
Coded flashing	<i>Radio remote control error – contact Service Centre</i>
Rapid flashing	<i>Malfunction in STOP circuit (see Chap. 9)</i>
One short flash	<i>EEPROM missing or not working</i>

Receiving Unit	
LED	Function
<i>Data Error ch. A (yellow LED)</i>	<i>On during operation Off during data errors on channel A</i>
<i>Passive Emergency ch. A (red LED)</i>	<i>Off during operation On when channel A is STOPPED System errors are indicated by coded flashing (similar to Morse code)</i>
<i>Data error ch. B (yellow LED)</i>	<i>On during operation Off during data errors on channel B</i>
<i>Passive Emergency ch. B (red LED)</i>	<i>Off during operation On when channel B is STOPPED System errors are indicated by coded flashing (similar to Morse code)</i>
<i>RF busy (green LED)</i>	<i>On when channel is occupied by radio signals Rapid flashing during dual transmission</i>
<i>Power Supply (green LED)</i>	<i>On when power supply is present</i>
<i>Working (green LED)</i>	<i>On when the two E-STOP relays are closed and the controls are enabled</i>

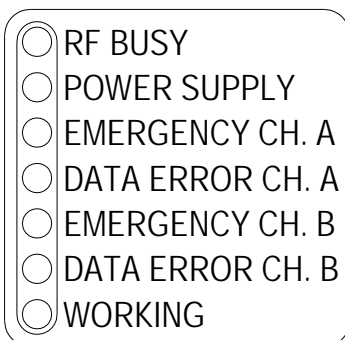

M receivers

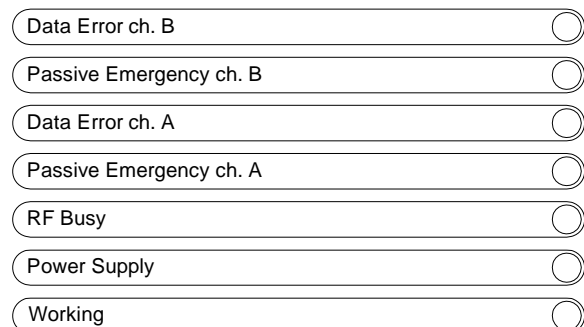

L, K, and H receivers

6.7. **Transmitting unit power supply**

Radio remote controls with portable transmitters are supplied complete with two rechargeable Ni-Mh batteries and a dedicated battery charger.

6.7.1. **Battery state of charge**

The battery's state of charge is shown by the green LED on the transmitting unit.

A steady green LED means the battery is charged.

A flashing green LED means the battery is low. Turn off the transmitting unit and change the battery. The LED begins to flash when the battery has power left for approximately 15 more minutes.

A low battery charge can also be indicated by an intermittent acoustic warning by connecting a horn to the respective relay output on the receiver, which in this case closes for 1 every 8 seconds.



6.7.2. **Changing and charging the battery**

Shut-off the transmitter unit, remove battery from its housing, and insert it into the battery charger.

In order to guarantee better battery duration and efficiency, it is best to use the charge until it completely empty, signalled by a green flashing LED on the Transmitter unit.

The battery charger must be powered through a conventional voltage line, without significant fluctuations, in order to not affect the intelligent charge process managed by the microcontroller.

The CB3600 and CB5000 type battery chargers are equipped with a green LED that indicates that power is present and a yellow LED that flashes 4 times when the battery is inserted (pre-charge) and remains on until charging is complete.



The battery charger is capable of detecting residual charge and battery capacity. The average charge time for a battery that has been discharged properly is 2-3 hours, in relation to residual charge and cell capacity. The charge cycle ends when the yellow LED shuts off.

It is possible that, while charging a battery that is completely empty, the flashing yellow LED phase (pre-charge) lasts several minutes.



If the flashing persists, clean the golden battery contacts using a soft cloth, if this problem continues, replace the battery with a new one.

it is best not to interrupt the charge by removing the battery from the housing, or by shutting off the battery charger once the yellow signal LED is no longer on.

The CB6000 type battery chargers are equipped with a single LED that has the same function of the yellow LED from the CB3600 and CB5000 battery chargers described above.

In order to extend battery life cycles, if possible, avoid charging batteries that are already completely or partially charged.

The battery charger is designed for indoor use: do not expose it to the elements. To preserve battery life recharge the battery in a place with no humidity and a temperature between 5°C and 45°C.

The battery charger's power plug should be installed close to the equipment and be easily accessible. In case of direct-voltage power supplies, the connection between the battery charger and the power supply should not be permanent. In this case, use a connector that can be disconnected at any time. If you are using a CB6000-DC battery charger (see Chap. 9.11), protect the connection with a fuse.



Warning: Explosion hazard if non-compatible batteries are used! Use IMET batteries only. See Chap. 11 for information on the disposal of exhausted batteries.

6.8. Dip-switch programmable output configurations

The receiving unit can be programmed to follow preset operation schedules for the more common applications (e.g., tower cranes, bridge cranes and industrial cranes). This is done using the dip-switches on the receiver. The dip-switches can be:





ON		<i>Enabled as per the tables below for WAVE transmitters (tables 0-5)</i>
OFF		<i>Enabled as per table 6 only</i>
		<i>Enabled as per the customizable tables shown in Annexes A, B, C</i>
		
	1 2 3 4	

Table 0: **For applications with gantry cranes:** The transmitter's commands are executed with no conditions posed by the receiver except for the interlock between right button and left button on the same line. The second speed commands are common: the second function of every pair of buttons on the same line produces the same command.

Table 1: **For applications with tower cranes:** Three speeds associated with three different buttons. While holding the main speed button pressed (A1 or A2), briefly press the second speed button (A3) or the third speed button (A4). They will remain effective until the main button is released.

Table 2: **For applications with tower cranes:** Same as in Table 1 but with controls A5...A8.









Table 3: **For applications with tower cranes:** Combines the functions of the two previous tables.

Table 4: **For applications with tower cranes:** Three speeds associated with two buttons with holding function. In this case the button's dual function is exploited, producing the main speed when pressed once and the second speed when pressed twice. The third speed is obtained with, respectively: A3 for button A1/B5 or A2/B5, and A4 for button A5/B7 or A6/B7.

Table 5: **For applications with gantry cranes:** This solution distinguishes the second-speed controls, which are normally the same for pairs of adjoining buttons.

Table 6: **DIP4 OFF:** Both the start and horn relays are activated every time the Start button is pressed.

DIP4 ON: The horn relay is activated the first time you press Start. Every time you press Start after that, both relays are activated.

Table 0	ON OFF  1 2 3 4	<i>Basic configuration: no self-holding</i>
Table 1	ON OFF  1 2 3 4	<i>A3 or (A3 and A4) held by A1 or A2</i>
Table 2	ON OFF  1 2 3 4	<i>A7 or (A7 and A8) held by A5 or A6</i>
Table 3	ON OFF  1 2 3 4	<i>Table 1 + Table 2</i>
Table 4	ON OFF  1 2 3 4	<i>A3 held by (A1+B5) or (A2+B5) A4 held by (A5+B7) or (A6+B7)</i>
Table 5	ON OFF  1 2 3 4	<i>Distinct second speeds</i>
Table 6	ON OFF  1 2 3 4	<i>Start and Horn configurable</i>
Table ...	ON OFF  1 2 3 4	<i>More functions customizable on request</i>

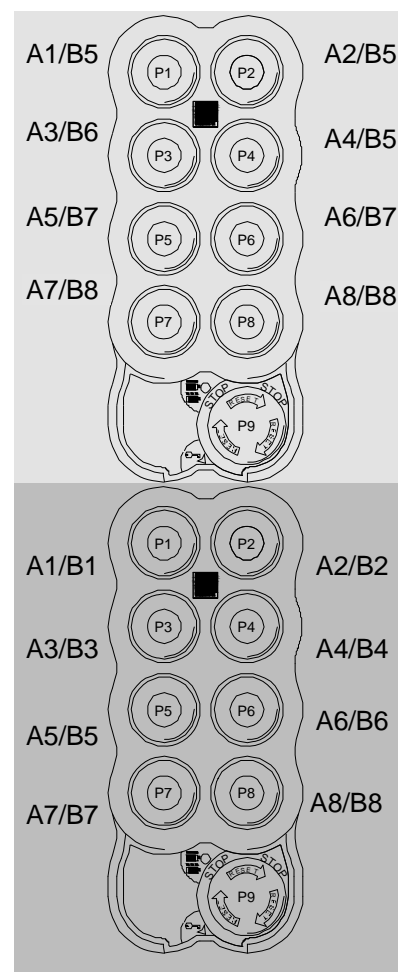

7. RADIO REMOTE CONTROL OPTIONS

These options may not be present in your radio remote control. Consult technical attachments and read the paragraphs for the options included with the radio remote control

7.1. MTRS and MTRS Easy Option

The transmitter-receiver multi system enables each receiver to be able to recognise a maximum of 8 transmitters with which it can operate one at a time, and every transmitter to be able to operate with a maximum of 16 receivers at the same time.

The MtrS and MtrS Easy option is available on the full range of transmitters and receivers apart from 4 transmitters recognisable on L and M receivers, whereas with the H series it can reach up to 8 transmitters. The MtrS and MtrS Easy are differentiated by the Lock and Unlock procedure described subsequently.

The MtrS or MtrS Easy option is indicated for all those application sectors which require for multiple operators to safely operate on the machines:

- Automatic warehouses
- Funicular cranes
- Overhead travelling crane

7.1.1. Transmitter

7.1.1.1. Definition of combination

The combination indicates which receivers have to work at the same time during the working session.

The combinations are personalised depending on the clients needs and are programmed by IMET during the radio remote control manufacture.

Each transmitter can handle up to 16 different receiver combinations with which it can operate at the same time.

The combinations may vary from one transmitter to another. The MtrS option enables to realise different functioning, typical of lifting machines:

- TANDEM
- MASTER-SLAVE
- CATCH-PITCH (TAKE-RELEASE)

7.1.1.2. Selecting the desired combination

Attention: if a toggle switch is not present, pass on to the next paragraph.

The desired receiver combination is selected using a rotating selector. Makes it possible to select the receivers and therefore the machines on intends to operate with. Once the desired work combination has been set, one must proceed with taking control of the receivers in order to guarantee that they are exclusively used by the transmitter.

7.1.1.3. Lock procedure

This procedure allows taking control of the receivers to guarantee the exclusive use on behalf of the transmitter.

Before proceeding, ensure that all receivers are free, meaning they are not already being exclusively used by other transmitters (see page 12).

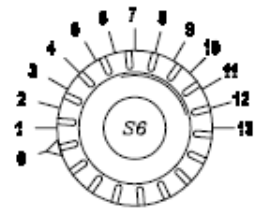

MtrS	MtrS Easy
<ul style="list-style-type: none"> • Keep the Lock button pressed (see technical attachments). • Press the start button for 1 s. • Once the Start button is released, verify that all selected receivers activate the lit signal of the transmitter with which it intends to operate. • Release the lock button. 	<p><u>Procedure unnecessary.</u> Once Start is pressed, all selected receivers will start (see paragraph 2.4)</p>

From this moment the receivers are for the exclusive use of the transmitter. No other transmitters will be able to control the selected receivers until the Unlock procedure is carried out

7.1.1.4. Radio remote control start-up

Once the initial conditions of the user manual are verified (Chap. 6.2), press the START button to operate. All selected receivers with the Lock procedure will activate and from this moment it will be possible to carry out the desired manoeuvres.

During the work session it is possible to switch from one combination to another. Before this operation, always interrupt the gear by pressing STOP. If not, the transmitter will automatically switch itself off.

If the receivers are already being exclusively used: choose the new desired combination with the rotating selector and press start.

If the receivers are not being used exclusively: choose the new desired combination with the rotating selector and repeat the desired Lock procedure. Then press START.

7.1.1.5. UNLOCK Procedure

Once the working session is finished, to once again be able to make the receivers available to other operators, it is necessary to free the receivers from the exclusive use of the transmitter.

MtrS	MtrS Easy
<ul style="list-style-type: none"> • Radio remote control <u>not started</u> • Choose a combination of receivers to be freed by way of the toggle switch (if the toggle switch is not present, pass on to the next point). • Keep the Unlock control pressed (see technical attachments). • Press the start key for 1 s. 	<ul style="list-style-type: none"> • Radio remote control <u>started</u> • Press the UNLOCK button for 1 s at the first click (see technical attachments)



Verify that all selected receivers deactivate the lit signal indicated the transmitter which had the exclusive control.

From this moment the receivers are free and can operate with the other transmitters which form part of the system.

7.1.1.6. Frequency change

The frequency change is carried out in the same mode described in chap 8 of the main manual.



The initial condition to be respected is that the transmitter must not have any selected receiver at exclusive use.

Attention: with the MtrS or MtrS Easy option, the receiver does not give any information that the frequency change has been carried out. Keep to the information of the LED of the transmitting unit

7.1.2. Receiver

Inside the receiver with the MtrS and MtrS Easy option there are outputs destined to the signalling the transmitter which, at that time, has exclusive use of the receiver. For safety, every machine will have to be equipped with lit signals which inform various operators which transmitter has the exclusive use of the receiver at that time.

The number of dedicated outputs are:

- From 1 to 4 for L and M receivers.

- From 1 to 8 for H receivers.

These outputs are activated with the Lock procedure and remain active even during work session interruption caused by the transmitter switching off. To deactivate them it is necessary to carry out the Unlock procedure or remove power to the receiver.



Any lack of power to the receiver will delete the priorities acquired by the transmitters. To reset the desired conditions choose the desired combination with the rotating selector and subsequently a lock procedure.

7.1.3. Anomalies

Some useful suggestions are given in this chapter, in addition to those in the main manual (Chap.9), in case anomalies in the functioning of the radio controls with MtrS or MtrS Easy option are verified (Chap. 6).

Anomaly	Possible solution
It is not possible to have exclusive control of the desired receivers.	Verify they are not already controlled by another TX: in this case, carry out an Unlock procedure with the transmitter controlling the desired receivers. Verify that the correct combination using the rotating selector has been chosen. Verify the combinations in the attachments.
It is not possible to free the receivers with the Unlock procedure.	A frequency change with the selected receivers has been carried out: switch off all interested receivers.
It is not possible to put the receivers selected previously with the Lock procedure into gear.	A frequency change with the selected receivers has been carried out: switch off all interested receivers and carry out the lock procedure again

7.2. DSC Option

When the transmitting unit has the two toggle switches represented in the image here on the right, it is possible to use the DSC function.

Under normal operational conditions where the snail (reduced speed) function is active, it may be necessary to temporarily correct analogue output calibration values without having to enter the programming phase.

For this reason, using a second 3 unstable position toggle switch (+/- toggle switch) it is possible to change reduced speed levels in real time for each joystick, in order to adapt the application's response to load and precision needs that are required at the moment.

With the DSC, reduced speed limits may vary within the minimum and maximum limits set in "hare" mode.



DSC+: increases the reduced speed limit as long as the joystick is at the end of its stroke.

DSC-: decreases the reduced speed limit. In this case joystick position is non influential.

Corrections carried out with the DSC remain valid until the receiver is turned off. The next time it is turned back on the limits that were previously programmed with the limits calibration will be restored. Turning only the transmitting unit off and on will not erase the corrections carried out with the DSC.



During the programming or test phase, for minimum and maximum limits of analogue outputs, the DSC function is not active.

The DSC function is excluded by the activation of the "Snail-S" mode.

7.3. iREaDy Option

With this option it is possible to activate the radio remote control only if pointing the transmitter towards a supplemental receiver unit called iREaDy receiver. Transition of the start signal takes place through an infrared ray combined with the normal radio signal.

The additional safety makes it possible to avoid involuntary and undesired start-up of the radio remote control and therefore of the system

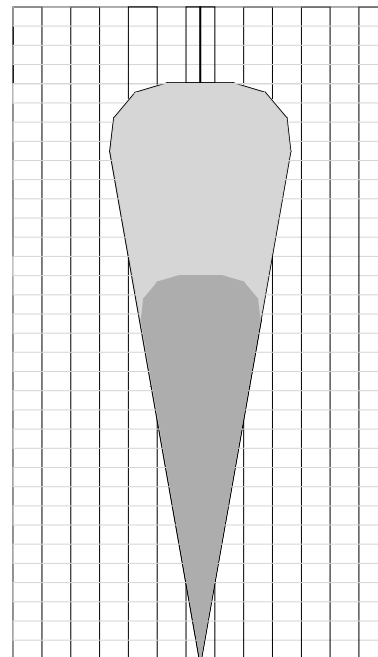

7.3.1. Warnings

Steps and behaviour to be adopted when using infrared:

- Do not look at the LEDs directly or point them directly towards someone's eyes.
- Do not attempt to replace or repair the LEDs, since these components cannot be replaced or repaired by the user.
- Do not scratch the lenses.

Periodically clean the lenses with a clean soft cloth

7.3.2. Transmitter

The transmitter with the iREaDy option is equipped with two led for infrared transmission. It is sufficient to point the transmitter towards the iREaDy receiver and press the Start key. Maximum transmission distance is:

- 30m with indirect solar light
- 20m with direct solar light

The transmitter will send the recognition code by way of radio and infrared. The application will only activate if both codes are recognised by their respective receivers.

7.3.3. Receiver

The iREaDy receiver must be installed close to the receiver of the radio remote control and connected according to the diagram shown below.

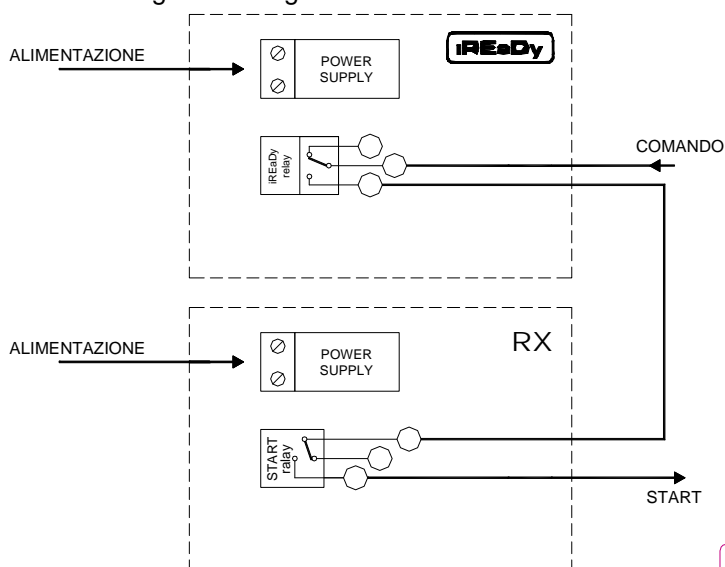

The power supply must conform to the requirements contained in paragraph 7.3.5. The following LED are present on the iREaDy receiver:

- LED for reception of the infrared signal (IR LED).
- Green DATA led: indicates reception of the infrared signal: it lights up every time the infrared reception LED receives a signal.

White START LED: indicates that the infrared signal is correct and the receiver activates the relay connected in series with the relay of the radio receiver

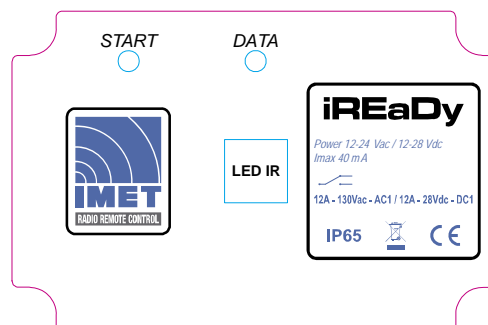

It is possible to connect multiple iREaDy in parallel according to the diagram shown here below

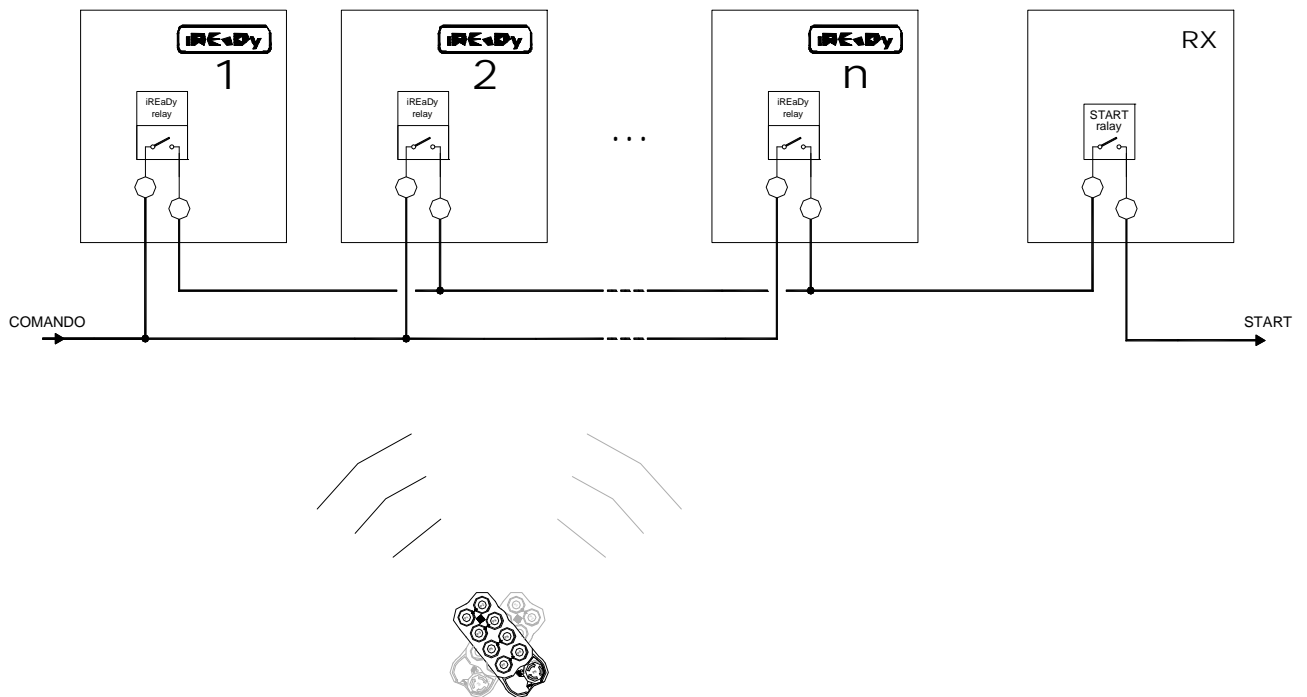

7.3.4. Operation

Once the initial conditions from the user manual have been verified (Chap. 6.2), proceed as follows:

- For one second, activate the START control pointing the front part of the pushbutton towards the infrared receiver with an angle of inclination and a distance that conforms to what is contained in paragraph 7.3.5.
- When the green LED switches on it indicates that the transmitter is functioning correctly.
- A temporary switch on of the green LED (DATA) on the infrared receiver indicates that the two units are aligned correctly.
- When the white LED (START) of the infrared receiver switches on, it indicates that the START command of the radio remote control has been activated. From this moment on, it is possible to carry out the commands.

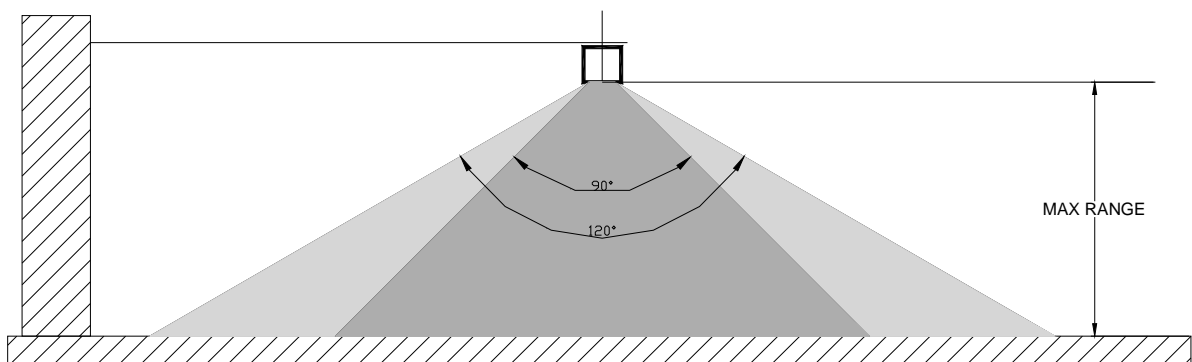

Range of action of the infrared receiver

7.3.5. Technical characteristics

Maximum distance between TX and RX

30 metres +/- 1 (indirect sun light)
20 metres +/- 1 (incident solar light with an angle greater than 45°)

IR transmitter data

- Emission angle
- Emission class of the Infrared transmitter
- Infrared modulation
- Combination addresses available for infrared

+/- 20° X/Y axis
1 (EN 60825-1)
PPM
65536

IR receiver data

- Power supply voltage
- Maximum absorption
- Sensitivity angle

- Maximum capacity of NC/NO relay contacts
- Maximum retention time of the relay from when the command is received from the transmitter
- IP degree
- Dimensions of the receiver
- Weight without bracket

12-28 Vac/ 12-28 Vdc
40 mA
60° X,Y axis (indirect solar light)
+/- 45° X,Y axis (incident solar light with an angle greater than 45°)
2A 250Vac - AC1 / 12A 28Vdc - DC1
3 seconds

65
mm 126x87x62 (L.P.H.)
0.2 Kg

8. CHANGING THE OPERATING FREQUENCY

Nearby radio devices transmitting on the same frequency channel may cause interference. To check for interferences, turn off the transmitter and check the “RF-busy” LED on the receiver: if the LED stays on it means that other devices are using the same frequency. If disturbances occur during operation, the “Data Error” LED will turn off every time the system detects a data reception error.

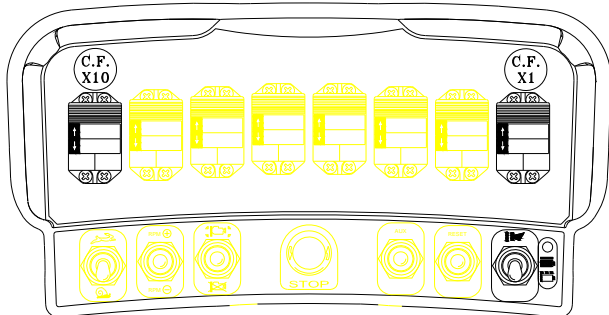

Reception errors lasting more than 0.8 seconds will put the receiver on **passive emergency** (see Chap. 8.2).

To change the operating frequency, choose another frequency channel. There are 30 channels available.

8.1. Before changing frequency

Make sure transmitter's battery is charged and insert the magnetic key (or, if you are using a G4 transmitter, turn the key to ON). Make sure the receiver is powered and bring the transmitter as close to the receiver as possible.

8.2. Changing frequency

Press the two frequency change controls (CF) at the same time (see Annex A for identification), and press and release the START button . The green ON light on the transmitter should flash 4 times and pause, repeatedly.

Release the two controls (CF).

Follow one of the two procedures below:

“Two step” procedure: Moving to the second upper channel. Press the START button  and make sure the LED flashes at regular intervals.

“Any step” procedure: Choose one of the 30 channels available using first the control for the tens (C.F.x10) and then the control for the units (C.F.x1) (see Annex A). Example: To select channel 26 on a WAVE transmitter, press control P1 (for the tens) 2 times and press control P2 (for the units) 6 times. Press the START button  and make sure the LED flashes at regular intervals.

At the end of either procedure wait for about 5 seconds. The transmitter will turn off. The device is now ready to operate using the new channel. The red LEDs on the receiver will flash, meaning the frequency change procedure is being executed.

Press START  to begin the command sequence. If the command sequence does not begin the frequency change procedure was not executed correctly. Turn off all devices and repeat the entire procedure.

NOTE on the “Any Step” procedure. If you press the tens control (C.F.x10) more than 3 times or the units control (C.F. x1) more than 9 times the count will restart from zero.

To select 0 tens or 0 units you do not need to press the respective controls. For example, to select channel 20, press the tens control (C.F.x10) 2 times, then press START  to execute the procedure.

If you select 3 tens, the units will be 0 whatever number you choose.

If the selected channel is disturbed by interferences, change the frequency again. Interference-free channels are indicated by the “RF Busy” LED on the receiver. The LED is off when the receiver is powered and on when the transmitter is on.

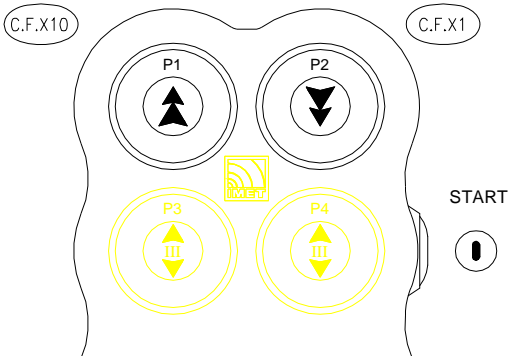
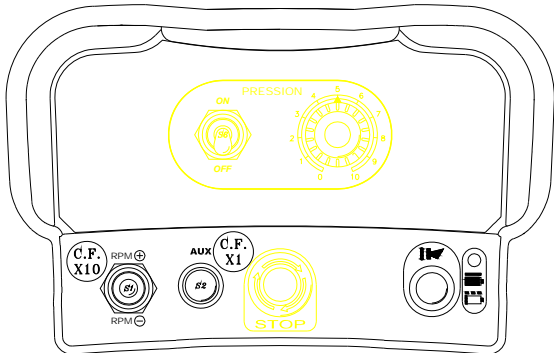
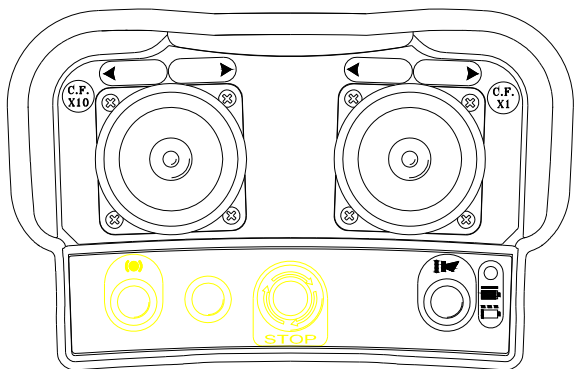

8.3. Available frequencies

Available Frequencies			
CHANNEL	FREQUENCY	CHANNEL	FREQUENCY
01	434.050 MHz	16	434.425 MHz
02	434.075 MHz	17	434.450 MHz
03	434.100 MHz	18	434.475 MHz
04	434.125 MHz	19	434.500 MHz
05	434.150 MHz	20	434.525 MHz
06	434.175 MHz	21	434.550 MHz
07	434.200 MHz	22	434.575 MHz
08	434.225 MHz	23	434.600 MHz
09	434.250 MHz	24	434.625 MHz
10	434.275 MHz	25	434.650 MHz
11	434.300 MHz	26	434.675 MHz
12	434.325 MHz	27	434.700 MHz
13	434.350 MHz	28	434.725 MHz
14	434.375 MHz	29	434.750 MHz
15	434.400 MHz	30	434.775 MHz



The table below shows the countries where the radio remote controls have been notified to the national authorities responsible for assigning radio frequencies, in compliance with Art. 6.4 of Directive 1999/5/CE.

Table updated to 26 June 2007

No.	Country	No.	Country
1	Austria	17	Lithuania
2	Belgium	18	Luxembourg
3	Bulgaria	19	Malta
4	Cyprus	20	Netherlands
5	Denmark	21	Poland
6	Estonia	22	Czech Rep.
7	Finland	23	Romania
8	France	24	Slovakia
9	Germany	25	Slovenia
10	Greece	26	Portugal
11	England	27	Spain
12	Ireland	28	Sweden
13	Iceland	29	Norway
14	Italy	30	Switzerland
15	Latvia	31	Hungary
16	Liechtenstein		



IMET radio remote controls comply with the specifications of ERC Recommendation 70-03 Annex1 Band E2. The national authorities for telecommunications may impose further restrictions or require use permits in the single countries.

We recommend that you become acquainted with the local laws before using the radio remote control. More information can be found on the following website:

<http://ec.europa.eu/enterprise/rte/weblinks.htm>

9. TROUBLESHOOTING

This chapter contains advice on handling malfunctions in the radio remote control.



First of all make sure that the problem actually depends on the remote control. To do so, operated the machine using the wired remote control instead of the radio remote control. The test is valid provided the same controls are tested and that the radio remote control and the wired remote control use the same connector.



Any tampering with the radio remote control or its components will automatically void the manufacturer's warranty

All repairs should be performed by qualified, authorized personnel and following the manufacturer's instructions.

Use original spare parts when making replacements, in order to preserve the original features of the radio remote control (see the list of replaceable parts in Chap. 10).

Radio Remote Control	
Problem	Possible Remedies
Limited operating range	<ul style="list-style-type: none"> Check the antenna and move it to a new location if necessary (see Chap. 5) Check the Data Error LEDs and change the frequency if necessary (see Chap. 7)
Certain functions perform improperly	<ul style="list-style-type: none"> See Annexes B and C
Transmitting Unit	
Problem	Possible Remedies
Transmitting unit does not turn on	<ul style="list-style-type: none"> Check battery charge Make sure the magnetic key is in place Make sure no controls are in the working position when you press START Make sure the STOP button is not pressed
LED flashes rapidly at start-up	<ul style="list-style-type: none"> Malfunction in the STOP circuit: see Chap. 8.1
LED makes one short flash at start-up, even if you keep pressing the Start button	<ul style="list-style-type: none"> Make sure the EEPROMs are correctly installed on both the receiver and the transmitter
At start-up the LED lights up only when you press the Start button	<ul style="list-style-type: none"> Check the contacts on the STOP button
Receiving Unit	
Problem	Possible Remedies
Receiving unit does not turn on	<ul style="list-style-type: none"> Check the protection fuses Check the power cables
Receiver turns on but does not operate the application, and the yellow LEDs are on	<ul style="list-style-type: none"> On the receiver, check the fuse in series to the STOP relay and the control relay Check the wiring between the receiver and the application
Receiver turns on but does not operate the application, and the red LEDs are on	<ul style="list-style-type: none"> Check the radio remote control's operating range Make sure the device is not in passive emergency; if so, change the frequency
Certain commands are not executed	<ul style="list-style-type: none"> Check the wiring between the receiver and the application
Battery Charger	
Problem	Possible Remedies
On the models CB500 and CB3600, the green "ON" LED does not turn on	<ul style="list-style-type: none"> Check the power cable Check the battery charging fuse
The "Charge" LED turns off after 5-20 minutes	<ul style="list-style-type: none"> Check input voltage stability
Battery charge does not last as long as expected	<ul style="list-style-type: none"> Charge the battery when its is completely exhausted Check the battery charger's power supply

9.1. Malfunctions in the transmitter's STOP circuit



If the green LED flashes rapidly and without interruption after you press START ① there may be a malfunction in the transmitting unit's STOP circuit. Test the radio remote control to verify the functioning of the STOP circuit.

The test is very simple: while the LED is flashing, press the STOP button and then the START button. The result should be one of the following:

- A) If the STOP circuit is in order, the transmitter will resume its normal operation after you reset the STOP button and press START.
- B) If the LED continues to flash rapidly after the test, repeat the test (for a maximum of 4 times) until the result is A or C.
- C) If the LED flashes and displays the error message "STOP circuit fault", contact an authorized Service Centre.



9.2. Passive emergency

Passive emergency is a safety mode automatically assumed by the system when it detects a malfunction (**clause 9.2.7.3 EN 60204-32**). The most common cause is a loss of RF connection between receiver and transmitter lasting more than 0.5 seconds due to:

- Strong disturbances on the transmission channel or a significant attenuation of the RF signal caused by an obstacle.
- Excessive distance between transmitter and receiver (out of range).

In all these situations, the receiver independently enters passive emergency mode, opens the E-STOP circuit and disables all the controls.

9.3. Technical Assistance

In case of malfunctions in the radio remote control that are not addressed in this manual, contact exclusively a Service Centre authorized by the manufacturer.

Contact the closest centre or the dealer where the device was purchased and provide the following information:

- Version of radio remote control
- Serial number
- Defect encountered
- Date of purchase

RX Unit Mod. M550S HAC	<input type="text"/>
Serial no.	<input type="text"/>

- Description and history of problem, status of receiver and transmitter LEDs during malfunction

RX Unit Mod. M550S LAC	<input type="text"/>
Serial no.	<input type="text"/>

TRX Unit Mod. M550D MAC	<input type="text"/>
Serial no.	<input type="text"/>

Keep this manual and the warranty certificate (filled out in every part) in a safe place.

10. TECHNICAL SPECIFICATIONS

<ul style="list-style-type: none"> • Manufacturer • Operating frequency • Modulation • Receiver sensitivity • F. offset block or desensitisation +/- (50-1000 KHz) • F. offset block or desensitisation +/- (2 MHz) 	<p>IMET S.r.l. I.S.M. Band 434.050 ÷ 434.775 MHz GMSK Dev. 3 kHz 0.22 uV 12 dB Sinad -40 dBm -25 dBm (Limit >= -69 dBm clause 9.4 ETSI EN 300-220-1) -10 dBm (Limit >= -44 dBm clause 9.4 ETSI EN 300-220-1)</p>
<ul style="list-style-type: none"> • F. offset block or desensitisation +/- (10 MHz) 	<p>25 KHz Simplex, (25 KHz Half Duplex)* 25K0F1D</p>
<ul style="list-style-type: none"> • Channelling • Emission designation • Number of programmable channels • Range • Hamming distance • Error non-detection probability • Available pairing addresses 	<p>30 \cong 100 m \geq 9 $<$ 7.34x10⁻¹² 65536</p>
<ul style="list-style-type: none"> • Delay time at receiver start-up • Delay time at start command • Command response time • STOP circuit response time • Passive emergency operate time 	<p>< 3 s < 750 ms < 110 ms, (< 120 ms)* < 150 ms, (< 220 ms)* < 500 ms (1200ms optional)</p>
<ul style="list-style-type: none"> • STOP circuit safety class • Movement commands safety class 	<p>4 (UNI EN 954-1) PL e (ISO 13849-1) 2 ÷ 3 (UNI EN 954-1) PL c ÷ PL d (ISO 13849-1) (see Annex B)</p>
Feedback controls safety class	1*(UNI EN 954-1)
<ul style="list-style-type: none"> • Number of safety controls 	PL c (ISO 13849-1) 2 (Safety-Stop, STOP)
<ul style="list-style-type: none"> • Operating and storing temperature range • Casing protection degree • Portable units housing material • Housing material of versions M-AC and M8 (DIN) • Fixed units housing material 	<p>-20°C ÷ +70°C (-4°F ÷ +158 °F) IP 65 (except for versions M and M8) Glass-filled nylon PVC ISONYL V0</p>
WAVE transmitters with H, L and K receivers	
<ul style="list-style-type: none"> • Max. number of ON/OFF commands • Number of service commands • Max. number of analog commands • Max. number of switch commands (optional) 	<p>16 (WAVE S), 20 (WAVE L)*, 24 (WAVE L) 1 Horn 1 4</p>
<i>* Transceiver version</i>	
WAVE transmitters with M receivers	
<ul style="list-style-type: none"> • Max. number of ON/OFF commands • Number of service commands • Max. number of analog commands • Max. number of switch commands (optional) 	<p>16 (WAVE S), 20 (WAVE L)*, 21 (WAVE L) 1 Horn 1 4</p>
<i>* Transceiver version</i>	
THOR, ZEUS, S1, S2, G4, M8 transmitters with H receivers	
<ul style="list-style-type: none"> • Max. number of ON/OFF commands • Number of service commands • Max. number of analog commands 	<p>48, 38* 4 (Start, Horn, Lamp, T-Stop) 8 (with 38 ON/OFF commands)</p>
<i>* Transceiver version</i>	
THOR, ZEUS, S1, S2, G4, M8 transmitters with L and K receivers	
<ul style="list-style-type: none"> • Max. number of ON/OFF commands • Number of service commands • Max. number of analog commands 	<p>20 1 ÷ 3 (Start; Horn and T-Stop optional) 8</p>

THOR, ZEUS, S1, S2, G4, M8 transmitters with M-AC receivers

- Max. number of ON/OFF commands 21
- Number of service commands 3 (Start, Horn and Blinker)
- Max. number of analog commands 4

10.1. WAVE transmitter

- RF emission power 10 mW ERP (internal antenna)
- Emission class 25K0F1D
- Oscillator type Synthesizer
- Power supply voltage 2.4 V DC
- Absorbed current 100 mA, 120mA*
- Max. absorbed power 0.3 W*
- IMET battery Ni-MH 2.4V 1.5 A/h
- Run time at 20 °C with charged battery, continuous operation \cong 15 hours, 12 hours*
- Low battery warning time \cong 15 min
- Liquid Crystal Display * 2 lines, 8 characters/line (30x15 mm)
- Visualization speed of characters on display* 100 char/s

10.2. THOR and ZEUS transmitters

- RF emission power 10 mW ERP (internal antenna)
- Emission class 25K0F1D
- Oscillator type Synthesizer
- Power supply voltage 3.6 V DC
- Absorbed current 160 mA, 180 mA*
- Absorbed power 0.58 W, 0.65 W*
- IMET battery Ni-MH 3.6V 1.7 A/h
- Run time at 20 °C with charged battery, continuous operation \cong 11 hours, 9 hours*
- Low battery warning time \cong 15 min
- Liquid Crystal Display* (Optional) 4 lines, 20 characters/line (75x27 mm)
- Liquid Crystal Display* (Standard) 2 lines, 16 characters/line (55x15 mm)
- Visualization speed of characters on display* 100 char/s

10.3. S1, S2 and G4 transmitters

- RF emission power 10 mW ERP (internal antenna)
- Emission class 25K0F1D
- Oscillator type Synthesizer
- Power supply voltage 6 V DC
- Absorbed current 90 mA, 110mA*
- Absorbed power 0.54 W, 0.66 W*
- IMET battery Ni-MH 6V 1 A/h
- Run time at 20°C with charged battery, continuous operation \cong 11 hours, 9 hours*
- Low battery warning time \cong 15 min
- Liquid Crystal Display* 2 lines, 16 characters/line (55x15 mm)
- Visualization speed of characters on display* 100 char/s

10.4. M8 transmitter

- RF emission power 10 mW ERP (external antenna)
- Emission class 25K0F1D
- Oscillator type Synthesizer
- Power supply voltage 12V÷28V AC/DC
- Absorbed current 240 mA, 260 mA*
- Absorbed power 1.40 W, 1.50 W*
- Liquid Crystal Display* (Optional) 4 lines, 20 characters/line (75x27 mm)
- Liquid Crystal Display* (Standard) 2 lines, 16 characters/line (55x15 mm)
- Visualization speed of characters on display* 100 char/s
- Max. number of ON/OFF outputs (NO relay)* 16
- Relay max. capacity* 6A 130V - AC1 / 6A 28V -DC1
- Input ports 21 digital, 8 analog

* Transceiver version

10.5. H receivers

- | | |
|---|---|
| • Type of RF receiver | Superheterodyne IF 83.16 MHz - 455 kHz |
| • RF emission power* | 10 mW ERP (internal antenna) |
| • Emission class* | 25K0F1D |
| • Oscillator type* | Synthesizer |
| • Power supply voltage | 24, 48, 55, 110 and 230 V AC, 12÷28 V DC |
| • Absorbed power | 20W Max |
| Maximum absorption | ≅ 0,9 A in AC / 1,2 A in DC |
| • Max. number of control relays (NC/NO) | 48 |
| • Number of service relays (NO) | 4 |
| • Max. number of analogue commands | 8 |

TYPE OF OUTPUT	TYPE OF COMMAND	OUTPUTS	AC POWER DATA	DC POWER DATA
E-STOP relay	Relay	1 NO	6A/130-250V AC1	6A/28V DC1
Safety-Stop relay	Relay	1 NO	6A/130-250V AC1	6A/28V DC1
Service relay	Relay	4 NO/NC	12A /130-250V AC1	12A/28V DC1
RST relay card	Relay	3 NO+ 12 NO/NC	12A /130-250V AC1	
RSA relay card	Relay	3 NO+ 12 NO/NC		12A/28V DC1
RMP relay card	Relay	10	12A /130-250V AC1	
RMA relay card	Relay	10		12A/28V DC1
PWM DAC+C1 current-operated analog card	Proportional analog	8		0 ÷ 1.4 A (F= 40÷150 Hz; F=200 ÷600 Hz)
DAC+C2 current-operated analog card	Proportional analog	8		0 ÷ 20 mA 4 ÷ 20 mA
DAC+V voltage-operated analog card	Proportional analog	8		25% ÷ 50% ÷75%V DC 0V DC ÷ (V DC-3) V DCmax=28V DC -10V DC ÷ 0V DC ÷ 10V DC

- | | |
|---|------------------------|
| • Input port* | Serial/Parallel |
| • Max. number of digital inputs* | 8 |
| • Max. number of analogue inputs | 4 |
| • Parallel port data exchange speed* | 50000 char/s |
| • Asynchronous serial port data exchange speed* | 4800/9600 bit/s |
| • * <u>Transceiver version</u> | |

10.6. L receiver

Type of RF receiver	Superheterodyne IF 83.16 MHz - 455 kHz
RF emission power*	10 mW ERP (internal antenna)
Emission class*	25K0F1D
Oscillator type*	Synthesizer
Power supply voltage	24 V AC, 48 ÷ 55 V AC, 110 V AC, 230 V AC, 12 - 28 V DC
Absorbed power	15W Max
Maximum absorption	≅ 0,9 A in AC; 1,2 A in DC
Max. number of control relays	20
Max. number of control relays (NC/NO)	4 with RLC relay cards 14 with RDC cards
Max. number of service relays (NO)	3 (between START, HORN, LAMP and T-STOP)
Max. number of DC command drivers	20
Max. number of analogue outputs	8

TYPE OF OUTPUT	TYPE OF COMMAND	OUTPUTS	AC POWER DATA	DC POWER DATA
E-STOP relay	Relay	1 (L-AC) 2 (L-DC)	6A/130-250V AC1	6A/28V DC1
Safety-Stop relay	Relay	1 NO	6A/130-250V AC1	6A/28V DC1
Service relay	Relay NO/NC	3 (AC version) 1 (DC version)	12A /130-250V AC1	12A/28V DC1
RLC relay card	Relay	16 NO+ 4 NO/NC	8A/130-250V AC1	
RDC relay card (L-DC only)	Relay	2 NO+ 14 NO/NC		12A/28V DC1
RMC relay card (L-DC only)	Relay	14 NO		16A/28V DC1
RLS driver card (L-DC only)	MOSFET	20		6A/28V (L=0) 2A/28V (L=10mH)
PWM ADD+C1 current-operated analog card	Proportional analog	8		0 ÷ 1.4 A (F= 40-150 Hz; F=200 ÷ 600 Hz)
ADD+C2 current-operated analog card	Proportional analog	8		0 ÷ 20 mA 4 ÷ 20 mA
ADD+V1 voltage-operated analog card	Proportional analog	8		25% ÷ 50% ÷ 75%V DC 0V DC ÷ (V DC-3) V DCmax=28V DC -10V DC ÷ 0V DC. ÷ 10V DC

- Input ports* **Serial/Parallel**
- Max. number of digital inputs* **8**
- Max. number of analog inputs* **4**
- Asynchronous serial port data exchange speed* **4800/9600 bit/sec**
- * Transceiver version

10.7. K receiver

Type of RF receiver	Superheterodyne IF 83.16 MHz - 455 kHz
RF emission power*	10 mW ERP (internal antenna)
Emission class	25K0F1D
Oscillator type*	Synthesizer
Power supply voltage	12 - 28 V DC
Absorbed power	15W Max
Maximum absorption	1,2 A in DC
Max. number of control relays	16
Max. number of control relays (NC/NO)	4 (only with RDC relay cards)
Max. number of service relays (NO)	3 (between START, HORN, LAMP and T-STOP)
Max. number of DC command drivers	20
Max. number of analog outputs	8

TYPE OF OUTPUT	TYPE OF COMMAND	OUTPUTS	AC POWER DATA	DC POWER DATA
E-STOP relay	Relay	1 NO		6A/28V DC1
Safety-Stop relay	Relay	1 NO		6A/28V DC1
Service relay	Relay NO/NC	3 NO		12A/28V DC1
RDC relay card	Relay	12 NO+ 4 NO/NC		12A/28V DC1
RMC relay card	Relay	14 NO		16A/28V DC1
RLS driver card	MOSFET	20		6A/28V (L=0) 2A/28V (L=10mH)
PWM ADD+C1 current-operated analog card	Proportional analog	8		0 ÷ 1.4 A (F= 40-150 Hz; F=200 ÷ 600 Hz)
ADD+C2 current-operated analog card	Proportional analog	8		0 ÷ 20 mA 4 ÷ 20 mA
ADD+V1 voltage-operated analog card	Proportional analog	8		25% ÷ 50% ÷ 75%V DC 0V DC ÷ (V DC-3) V DCmax=28V DC -10V DC ÷ 0V DC. ÷ 10V DC

- | | |
|--|----------------------------|
| • Input ports* | CAN/Serial/Parallel |
| • Max. number of digital inputs* | 8 |
| • Max. number of analog inputs* | 4 |
| • CAN bus interface data exchange speed* | <= 500 kbit/s |

* Transceiver version

10.8. M-AC receivers

Type of RF receiver	Superheterodyne IF 83.16 MHz - 455 kHz
RF emission power*	10 mW ERP (external antenna)
Emission class*	25K0F1D
Oscillator type*	Synthesizer
Power supply voltage	12 ÷ 28 V AC / 12 ÷ 28 V DC
Absorbed power	20W Max
Maximum absorption	1,2 A in DC
Max. number of control relays	17
Max. number of control relays (NC/NO)	4
Max. number of service relays (NO)	3 (START, HORN, LAMP)
Max. number of analog outputs	8

TYPE OF OUTPUT	TYPE OF COMMAND	OUTPUTS	AC POWER DATA	DC POWER DATA
E-STOP relay	Relay	1 NO	6A/130V AC1	6A/28V DC1
Safety-Stop relay	Relay	1 NO	6A/130V AC1	6A/28V DC1
Service relay	Relay	3 NO	6A/130V AC1	6A/28V DC1
Control relay	Relay	17 NO 4 NO/NC	6A/130V AC1	6A/28V DC1
ADD+V1 voltage-operated analog card	Proportional analog	4		25% ÷ 50% ÷ 75%V DC 0V DC ÷ (V DC-3) V DCmax=28V DC -10V DC ÷ 0V DC ÷ 10V DC
ADD+C2 current-operated analog card	Proportional analog	4		0 ÷ 20 mA 4 ÷ 20 mA

Data acquisition input ports*	RS232/RS485/Parallel
Max. number of digital inputs*	8
Max. number of analog inputs*	4
Parallel port data exchange speed*	50000 char/s
Asynchronous serial port data exchange speed*	4800/9600 bit/s

* Transceiver version

Transmitter dimensions

WAVE S	75x43x180 mm (L.W.H.)
WAVE L	75x43x245 mm (L.W.H.)
THOR	296x152x147 mm (L.W.H.)
THOR with display	296x190x147 mm (L.W.H.)
ZEUS	212x133x147 mm (L.W.H.)
ZEUS with display	212x169x147 mm (L.W.H.)
S1, S2	175x115x135 mm (L.W.H.)
G4	430x225x180 mm (L.W.H.)
M8	180x120x73 mm (L.W.H.)

Transmitter weight (battery included)

WAVE S	≅0.375 kg
WAVE L	≅0.465 kg
THOR	≅1.450 kg
ZEUS	≅1.090 kg
S1	≅1.050 kg
S2	≅1.200 kg
G4	≅ 4.000 kg
M8	≅0.910 kg

Receiver dimensions

H series	205x280x130 mm (L.W.H.)
L and K series	145x65x225 mm (L.D.H)
M series	180x120x73 mm (L.D.H)

Receiver weight

H series	≅3.500 kg
L and K series	≅1.700 kg
M series	≅0.910 kg

necessary strength of fastening tools

H series	≥ 100N
L and K series	≥ 50N
M series	≥ 50N

10.9. CB5000-AC, CB5000-DC battery chargers for WAVE transmitters

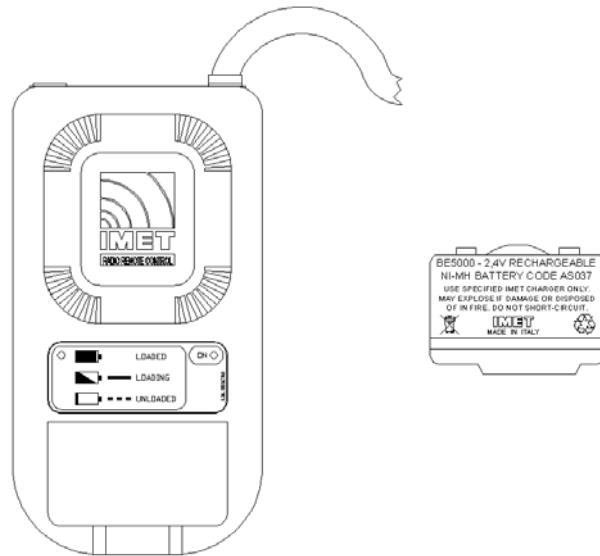

- | | | |
|---|------------|--|
| <ul style="list-style-type: none"> • Power supply voltage • Power demand • Charging current • IMET battery • Max. charging time • Type of charge • Casing protection degree • Operating temperature during charge • Storage temperature (charger off and without battery) • Dimensions • Weight • Weight including 230V AC transformer (optional) | PVD | <p>11÷32V DC (230V AC optional)
 32mA AC/ 230mA DC (during charge)
 ≈ 650mA
 Ni-MH 2.4V 1.5 A/h
 3 hours</p> <p>IP30
 +5 ÷ +45°C (+41 ÷ +113 °F)
 -20 ÷ +70°C (-4 ÷ +158 °F)
 75x49x142 mm (L.W.H.)
 250g
 490g</p> |
|---|------------|--|

10.10. CB3600-AC, CB3600-DC battery charger for THOR and ZEUS transmitters

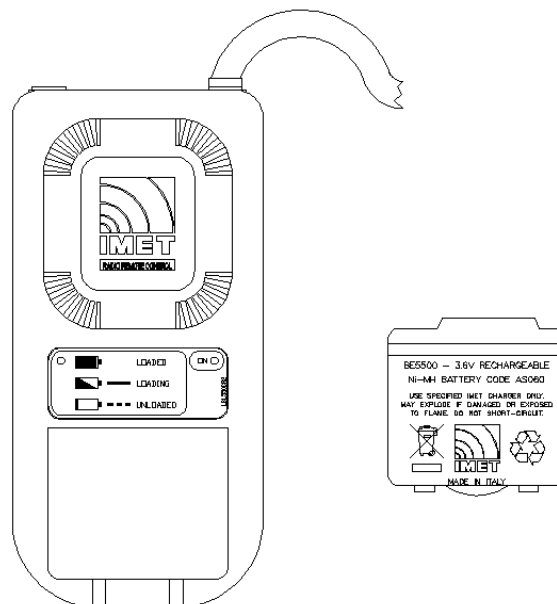

- | | |
|--|---|
| <ul style="list-style-type: none"> • Power supply voltage • Power demand • Charging current | <p>12÷32V DC (230V AC optional)
 35mA AC/250mA DC (during charge)
 ≈ 650mA</p> |
|--|---|

- IMET battery **Ni-MH 3.6V 1.7 A/h**
- Max. charging time **3 hours**
- Type of charge **PVD**
- Casing protection degree **IP30**
- Operating temperature during charge **0°C ÷ +35°C (+32°F ÷ +95 °F)**
- Storage temperature (charger off and without battery) **-20°C ÷ +70°C (-4°F ÷ +158 °F)**
- Dimensions **75x49x156 mm (L.W.H.)**
- Weight **251 g**
- Weight including 230V AC transformer (optional) **491 g**

10.11. **CB6000-AC, CB6000-DC battery charger for S1, S2 and G4 transmitters**

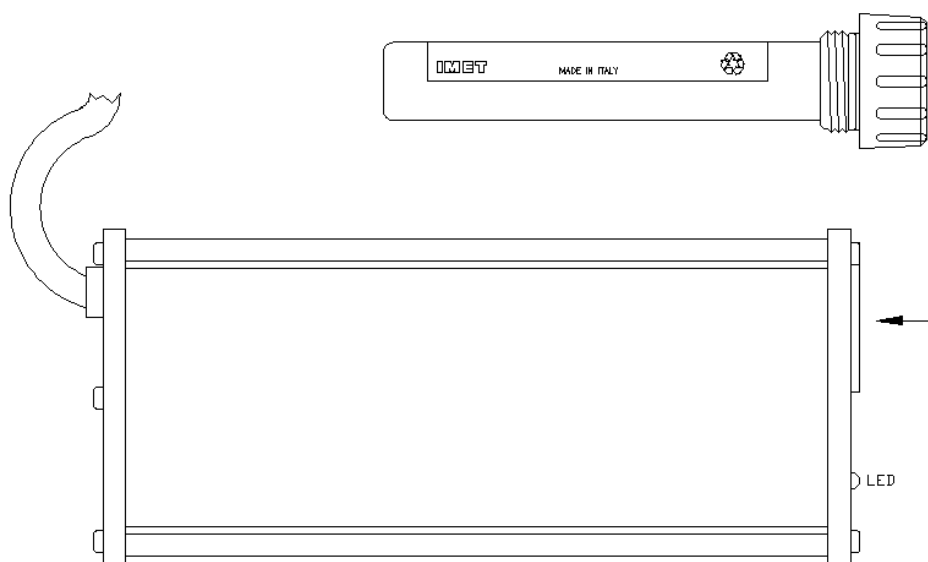

- Power supply voltage **12÷32V DC (230V AC optional)**
- Power demand **26mA AC/ 190mA DC (during charge)**
- Charging current **≅ 450mA**
- IMET battery **Ni-MH 6V 1 A/h**
- Max. charging time **3 hours**
- Type of charge **PVD**
- Casing protection degree **IP30**
- Operating temperature during charge **+5 ÷ +45°C (+41 ÷ +113 °F)**
- Storage temperature (charger off and without battery) **-20°C ÷ +70°C (-4°F ÷ +158 °F)**
- Dimensions **137x94x260 mm (L.W.H.)**
- Weight **250g**
- Weight including 230V AC transformer (optional) **620g**

11.RADIO REMOTE CONTROL SPARE PARTS LIST

Transmitting units and battery charger

Description	Item code
Reed contact key	AS038
Key for rotary selector	AS015
Shoulder strap	AS013
CB5000-AC 230 V AC battery charger with Italian plug	CR010
CB5000-AC 230 V AC battery charger with Schuko plug	CR012
CB5000-DC 11 ÷ 32 V DC battery charger	CR011
2.4V 1.5 A/h Ni-MH battery	AS037
CB3600-AC 230 V AC battery charger with Italian plug	CR016
CB3600-AC 230 V AC battery charger with Schuko plug	CR017
CB3600-DC 12 ÷ 32 V DC battery charger	CR018
3.6V 1.7 A/h Ni-MH battery	AS060
CB6000-AC 230 V AC battery charger with Italian plug	CR008
CB6000-AC 230 V AC battery charger with Schuko plug	CR009
CB6000-DC 12 ÷ 32 V DC battery charger	CR007
6V 1 A/h Ni-MH battery	AS034
F1 fuse 5x20 T 50mA L250V for CB5000-AC	FS031
F1 fuse 5x20 T 50mA L250V for CB3600-AC	FS031
F1 fuse 5x20 T 1A L250V for CB5000-DC	FS029
F1 fuse 5x20 T 1.25 L250V for CB3600-DC	FS002

H receiver

Description	Item code	Remarks
F1 fuse 5x20 T 1.25A L250V	FS002	
F2 24, 55V fuse 5x20 T 1.25A L250V	FS002	For AC versions only
F2 110,230V fuse 5x20 T 0.63A L250V	FS001	For AC versions only
F3 fuse 5x20 T 5A L250V	FS005	
F4 fuse 5x20 T 5A L250V	FS005	For AC versions only

L and K receivers

Description	Item code	Remarks
F10 230V fuse 5x20 T 80 mA L250V	FS035	For L-AC only
F10 110V fuse 5x20 T 200 mA L250V	FS034	For L-AC only
F10 24-55V fuse 5x20 T 315 mA L250V	FS033	For L-AC only
F10 fuse 5x20 T 1.25A L250V	FS002	
F11 fuse 5x20 T 5A L250V	FS005	
F12 fuse 5x20 T 5A L250V	FS005	
F13 fuse 5x20 T 1.25A L250V	FS002	For L-AC only

M-AC receivers

Description	Item code
F1 fuse 5x20 T 1.25A L250V	FS002
F2 fuse 5x20 T 5A L250V	FS005
F3 fuse 5x20 T 5A L250V	FS005

12.DISPOSAL

Once it is no longer in use, the radio remote control should be handed over to the local waste disposal service.



The symbol of the crossed-out waste container on the device means that it must be handled separately from normal waste. The owner is responsible for handing over scrapped equipment to the designated points of collection for the recycling of electric or electronic waste material.



Waste separation contributes to protecting the environment and facilitates recycling.

Exhausted batteries should be disposed of at the specific points of collection, as required by law.

Illegal disposal of the product is punished (in Italy) by the penalties indicated in Legislative Decree no. 22/1997 (Art. 50 et seq.) implementing European Directive 2002/96/CE.

ANNEXES

This manual is completed by the following Annexes indicating specific information on the project number by which the radio remote control is identified.

Annex A

Arrangement and electric symbols of the actuators in the transmitting unit.

Annex B

Table of controls.

Annex C

Wiring diagram of the outputs in the receiving unit.

Annex D for K-DC receivers

Details of CAN bus interface.

Other annexes

Special functions

13. DECLARATION OF CONFORMITY



The IMET Radio Remote Control, model M550		
<i>Date of installation</i>	<i>Year of manufacture</i>	<i>Serial no.</i>

ID TRANSMITTING UNIT	M550	
ID RECEIVER UNIT	M550	

is suitable

for installation on machines or other equipment conforming with European Directive 2006/42/EC ("Machinery Directive")

and conforms with the technical requirements of the following standards and/or technical specifications

- IEC/EN 60950-1:2006
- EN 50371:2002
- EN 60204-32:2008
- EN 62061: 2005
- ISO 13849-1:2006
- EN 13557/A2: 2008

Additional information required by Standard UNI EN ISO 13849-1:2008 and EN 62061: 2005

STOP circuit:

PL e, Category 4, SIL3

Joystick controls:

PL d, Category 3, SIL2 with Safety STOP activated

Toggle switch controls:

PL c, Category 2, SIL1 with Safety STOP activated

- EN 60529: 1991 +A1:2000
- EN 61000-6-2 (2005)
- EN 301 489-1 v 1.8.1
- EN 301 489-3 v 1.4.1
- EN 300 220-1 v 2.1.1
- EN 300 220-2 v 2.1.2

regarding the protection requirements established by the following EC directives

- 1999/5/EC (Directive R&TTE)
- 2006/42/EC (Machinery Directive)

Sacile,

IMET S.r.l.
 Evio Cadarin, President

